

## KRAL processing unit

BEM 100

SW 1.06

OIE 26en-GB  
Edition 2021-08  
Original instructions

<b>1 About this document</b> .....	<b>3</b>	9.1.1 Setting the Modbus address .....	16
1.1 Target groups .....	3	9.1.2 Managing the density table .....	16
1.2 Associated documents .....	3	9.1.3 Entering the density table .....	17
1.3 Symbols .....	3	9.1.4 Selecting the mode for volume measurement .....	18
1.3.1 Danger levels .....	3	9.1.5 Specifying the reference temperature for temperature compensation .....	18
1.3.2 Danger signs .....	3	9.1.6 Smoothing the indication .....	18
1.3.3 Symbols in this document .....	4	9.1.7 Selecting the mode for pulse evaluation .....	18
<b>2 Safety</b> .....	<b>4</b>	9.1.8 Specifying the maximum flow rate .....	19
2.1 Proper use .....	4	9.1.9 Specifying the minimum flow rate .....	19
2.2 Foreseeable misuse .....	4	9.2 Reading the measured values and status information .....	19
2.3 Fundamental safety instructions .....	4	9.2.1 Synchronizing measured values .....	19
<b>3 Identification</b> .....	<b>4</b>	9.2.2 Clearing error messages .....	20
3.1 Rating plate .....	4	<b>10 Maintenance</b> .....	<b>20</b>
<b>4 Technical data</b> .....	<b>5</b>	10.1 Required maintenance .....	20
4.1 Ambient conditions .....	5	10.2 Cleaning the electronic unit .....	20
4.2 Dimensional drawing .....	5	<b>11 Disposal</b> .....	<b>21</b>
4.3 Power supply .....	5	11.1 Disposing of the electronic unit .....	21
4.4 Modbus interface .....	6	<b>12 Troubleshooting</b> .....	<b>21</b>
4.5 Cable specification .....	6	12.1 Status LEDs .....	21
4.6 Pin assignment .....	6	12.2 Fault table .....	21
<b>5 Function description</b> .....	<b>6</b>	12.3 Error tree: No communication .....	22
5.1 Functional principle .....	6	12.4 Error tree: No flow .....	23
5.1.1 Usage .....	6	12.5 Error tree: Flow unusually high .....	23
5.1.2 Communication .....	6	12.6 Error tree: Flow rate varies too much .....	23
5.1.3 Volume measurement .....	7		
5.1.4 Linearization .....	7		
5.1.5 Density determination .....	7		
5.1.6 Mass measurement .....	7		
5.1.7 Differential measurement and synchronization .....	7		
5.1.8 Averaging .....	7		
5.2 Modbus communication .....	8		
5.2.1 Supported Modbus functions .....	8		
5.2.2 Sequence of the data values .....	8		
5.2.3 Legend for the parameter tables .....	8		
5.2.4 Protected parameters .....	8		
5.2.5 Automatically updated parameters .....	9		
5.2.6 Parameters for configuration .....	9		
5.2.7 K-factor table .....	10		
5.2.8 Density tables .....	11		
5.2.9 Error messages .....	12		
5.2.10 Parameter for clearing error messages .....	13		
<b>6 Transportation, storage</b> .....	<b>13</b>		
6.1 Unpacking and checking the state of delivery .....	13		
6.2 Transporting the electronic unit .....	13		
6.3 Storing the electronic unit .....	13		
<b>7 Installation, removal</b> .....	<b>14</b>		
7.1 Dangers during installation, removal .....	14		
7.2 Installing the processing unit .....	14		
7.3 Removing the processing unit .....	14		
<b>8 Connection</b> .....	<b>14</b>		
8.1 Dangers during connection work .....	14		
8.2 Connecting the processing unit .....	14		
<b>9 Operation</b> .....	<b>16</b>		
9.1 Carrying out the basic settings .....	16		

## 1 About this document

### 1.1 Target groups

The instructions are intended for the following persons:

- Persons who work with the product
- Operator-owners who are responsible for the use of the product

Persons who work with the product must be qualified. The qualification ensures that possible dangers and damage to property that are connected to the activity are detected and avoided. These persons are qualified personnel who carry out the work properly due to their training, knowledge and experience and on the basis of the relevant provisions.

Information on the qualification of the personnel is provided separately at the beginning of the individual chapters in these instructions. The following table provides an overview.

Target group	Activity	Qualification
Fitter	Mounting, connection	Qualified personnel for mounting
Electrician	Electrical connection	Qualified personnel for electric installation
Trained personnel	Delegated task	Personnel trained by the operator-owner who know the task delegated to them and the possible dangers arising through improper behaviour.



Tab. 1: Target groups

### 1.2 Associated documents

- Declaration of conformity according to EU Directive 2014/30/EU
- Corresponding operating instructions of the flowmeter
- Corresponding operating instructions of the sensor
- Calibration certificate

### 1.3 Symbols

#### 1.3.1 Danger levels

	Signal word	Danger level	Consequences of non-observance
	DANGER	Immediate threat of danger	Serious personal injury, death
	WARNING	Possible threat of danger	Serious personal injury, invalidity
	CAUTION	Potentially dangerous situation	Slight personal injury
	ATTENTION	Potentially dangerous situation	Material damage









#### 1.3.2 Danger signs

	Meaning	Source and possible consequences of non-observance
	Electrical voltage	Electrical voltage causes serious physical injury or death.

## 2 Safety

### 2.1 Proper use

#### 1.3.3 Symbols in this document

	Meaning
	Warning personal injury
	Safety instruction
	Request for action
1. 	Multi-step instructions for actions
2. 	
3. 	
	Action result
	Cross-reference

## 2 Safety

### 2.1 Proper use

Use the processing unit only within the operating limits specified in the chapter "Technical data".

### 2.2 Foreseeable misuse

- Any use that extends beyond the proper use or any other use is misuse.

### 2.3 Fundamental safety instructions



#### The following safety instructions must be observed:

- Read the operating instructions carefully and observe them.
- Have work only carried out by qualified personnel/trained personnel.
- Wear personal protective equipment and work carefully.
- Observe the operating instructions of the flowmeter and of the sensors.

## 3 Identification

### 3.1 Rating plate

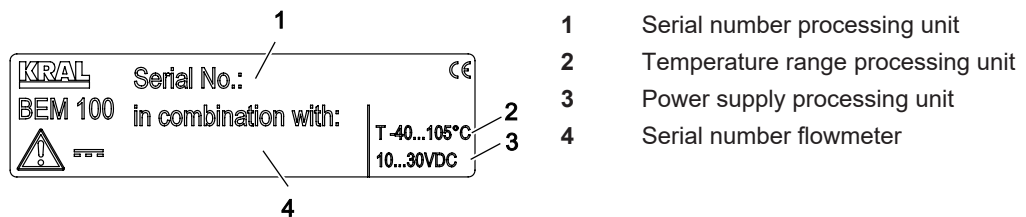

Fig. 1: Rating plate processing unit

## 4 Technical data

### 4.1 Ambient conditions

Parameter	Unit	Value min.	Value max.
Storage temperature	[°C]	-40	+105
Operating temperature	[°C]	-40	+105
Humidity relative (not condensing)	[%]	10	90
Vibration (@ 20 mm/s, ± 1.0 g max.)	[Hz]	5	50
Degree of protection		IP 67	

Tab. 2: Ambient conditions

### 4.2 Dimensional drawing

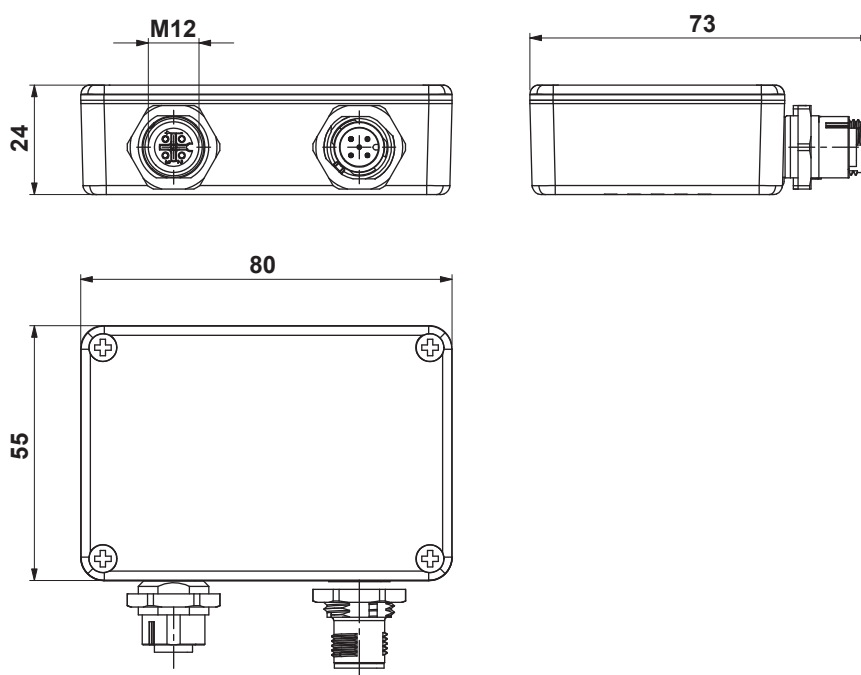

Fig. 2: Dimensional drawing processing unit

Parameter	Unit	Value
L x W x H	[mm]	80 x 73 x 24

Tab. 3: Dimensions

### 4.3 Power supply

Parameter	Unit	Value min.	Value max.
Power supply	[VDC]	10	30
Current consumption	[mA]	–	40
Insulation voltage	[V]	500	

Tab. 4: Power supply

## 5 Function description

### 4.4 Modbus interface

#### 4.4 Modbus interface

Parameter	Value
Interface type	RS-485
Baud rate	9600 / 19200 / 38400 / 57600 / 115200
Protocol	Modbus RTU
Data format	8N1 (8 data bits, no parity, 1 stop bit)
Refresh time parameter	1/16 [s]

Tab. 5: Modbus interface

#### 4.5 Cable specification

**Note** The manufacturer recommends the observance of the cable specifications at the cables used.

Parameter	Unit	Value
Conductors		<input type="checkbox"/> 2 x power supply ( $\geq 1 \text{ mm}^2$ ) <input type="checkbox"/> 2 x Modbus communication, twisted-pair and shielded ( $\geq 0,25 \text{ mm}^2$ )
Terminating resistor	[ $\Omega$ ]	120 (between A and B)
Cable diameter		For opening M12
Length max.	[m]	300 (at full load)

Tab. 6: Cable specification

#### 4.6 Pin assignment

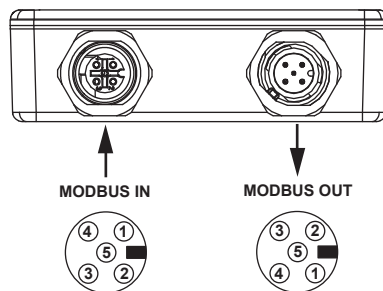

Fig. 3: Pin assignment

Pin	Description
1	Shield
2	DC power supply 10–30 V (+)
3	DC power supply 0 V (- or GND)
4	RS-485 A / + / RXTX-P (positive)
5	RS-485 B / - / RXTX-N (negative) / inverted

Tab. 7: Pin assignment

## 5 Function description

### 5.1 Functional principle

#### 5.1.1 Usage

The processing unit is intended for usage with a KRAL flowmeter of the OME Compact series and is mounted directly on the flowmeter.

Flowmeters generate a specific number of pulses per flow volume unit – depending on the size and working point. This device-specific characteristic is called the K-factor (unit: pulses/litre) and is specified on the calibration certificate.

#### 5.1.2 Communication

The processing unit operates with a Modbus connection (single-bus architecture). Pre-assembled cables serve to supply electricity and to transfer signals to an external display device, such as a PC or laptop (Human-Machine Interface / HMI). There the calculated measured results can be displayed.

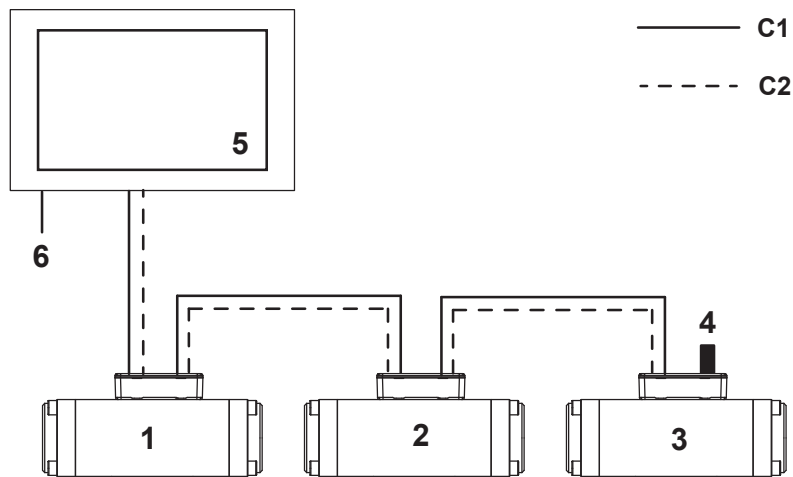

Fig. 4: Connecting several processing units

1	Flowmeter with processing unit	5	Display device (HMI)
2	Flowmeter with processing unit	6	Power supply display device
3	Flowmeter with processing unit	C1	Power supply processing unit
4	Terminating resistor	C2	Connection Modbus RS-485

Up to 32 processing units can be connected (32 sensor evaluations electrically in parallel).

### 5.1.3 Volume measurement

The volume is calculated cyclically by counting of the pulses divided by the K-factor (in pulses/liter). The flow rate is always defined by volume/time unit.

- The totalled overall flow ("Total\_Volume\_1" parameter) can only be reset in the works.
- The totalled overall flow ("Total\_Volume\_2" parameter) can only be reset by the user.

### 5.1.4 Linearization

The K-factor of a flowmeter shows slightly different values at different flow rates. These are documented in the enclosed calibration certificate. In order to improve the measuring precision these different values can be taken into consideration by means of a "Linearization". To this purpose the K-factors are stored for a maximum of eight interpolation values. The K-factor relevant for the currently measured flow rate is then determined with linear interpolation between the two nearest interpolation values.

### 5.1.5 Density determination

The flowmeters are equipped with a temperature sensor.

The density of the medium is determined by means of the measured temperature. To this purpose the processing unit provides six different modes:

- Density calculation for fuel oils LDO/MDO or HFO (Mode 4, 5, 6)  
Here only the density at 15 °C has to be entered.
- Density calculation for other media (Mode 0, 1, 2)

### 5.1.6 Mass measurement

The mass is calculated from volume times density.

### 5.1.7 Differential measurement and synchronization

Two flowmeters are used for differential measurement - one flowmeter in the feed line and one flowmeter in the return line. The "Hold" function is available for the synchronization. This function allows the HMI to set the output registers of the processing units briefly to "Hold" and thus to fetch the measured values for the differential generation – at the current moment – while in the background the processing units continue to measure the pulses received from the flowmeters and carry out all calculations.

### 5.1.8 Averaging

A strongly fluctuating flow rate causes the display to jump, making an interpretation by the user difficult. The averaging function reduces this effect by generating an averaging across several measured values.

## 5 Function description

### 5.2 Modbus communication

#### 5.2 Modbus communication

##### 5.2.1 Supported Modbus functions

Code	Modbus function	Register	Application examples
03 <sub>Hex</sub>	READ HOLDING REGISTERS	4xxxx	- Reading out of measured values, counter statuses, average values - Reading out of the device configuration
10 <sub>Hex</sub>	PRESET MULTIPLE REGISTERS	4xxxx	- Device programming

Tab. 8: Modbus functions

**Note** The maximum size of a data packet is 125 registers (words).

##### 5.2.2 Sequence of the data values

Reg_H (Bit 15..0)		Reg_L (Bit 31..16)	
HByte	LByte	HByte	LByte
1.	2.	3.	4.

Tab. 9: Data type: 32-bit value

Reg_H (Bit 15..0)		Reg_L (Bit 31..16)		Reg_H (Bit 47..32)		Reg_L (Bit 63..48)	
HByte	LByte	HByte	LByte	HByte	LByte	HByte	LByte
1.	2.	3.	4.	5.	6.	7.	8.

Tab. 10: Data type: 64-bit value

##### 5.2.3 Legend for the parameter tables

<b>Address</b>	Start address of the data (= actual data address to be sent = register address minus 1)
<b>Type</b>	Data type <input type="checkbox"/> U = unsigned Integer (without sign) <input type="checkbox"/> I = signed Integer (with sign) <input type="checkbox"/> 16 / 32 / 64 bits
<b>Length</b>	Number of words (16 bits = 1 word)
<b>DEC</b>	Correction factor for value calculation because the Modbus data definition only allows integer values. <input type="checkbox"/> During reading of the Modbus addresses the response values received by the program (HMI) are divided by DEC. <input type="checkbox"/> During writing of the Modbus addresses the response values to be sent by the program (HMI) are multiplied by DEC. (DEC = 10 <sup>n</sup> ; n = Number of decimal places)

Tab. 11: Legend

**Note** The numbering of the register addresses starts at 1, the data addressing at 0. This is how e.g. when reading register 1 the data address 0 is used.

##### 5.2.4 Protected parameters

These parameters are set in the works and cannot be changed by the user.

Name	Description	Address	Type	Length	DEC
Serial_Number	Manufacturer-specific ID	0x00	U32	2	10 <sup>0</sup>
Device_ID	Serial number processing unit	0x02	U32	2	10 <sup>0</sup>
Boot_Count	Number of device starts	0x04	U16	1	10 <sup>0</sup>
Hardware	Version hardware	0x05	U16	1	10 <sup>2</sup>
Software	Version software	0x06	U16	1	10 <sup>2</sup>
Total_Volume_1	Total value, cannot be reset [I]	0x08	I64	4	10 <sup>3</sup>
Operation_hours	Number of operating hours	0x0C	U16	1	10 <sup>0</sup>

Tab. 12: Protected parameters



### 5.2.5 Automatically updated parameters

These parameters are automatically updated by the processing unit 16 times per second, meaning that the updating interval for the Modbus data amounts to 62.5 ms.

Name	Description	Address	Type	Length	DEC
Alarm_Read	Error message	0x14	U32	2	10 <sup>0</sup>
Hold_Timer	Sets the processing unit to Hold mode for x ms	0x16	U16	1	10 <sup>0</sup>
Total_Volume_2	Total value since last reset [l]	0x18	I64	4	10 <sup>3</sup>
Avg_Flow_Rate	Average flow rate [l/h]	0x1C	I32	2	10 <sup>2</sup>
Temperature	Current temperature of the pumped liquid [°C]	0x1E	I16	1	10 <sup>1</sup>
Flow_Dir_Change	Counter for direction change	0x1F	U16	1	10 <sup>0</sup>

Tab. 13: Automatically updated parameters

### 5.2.6 Parameters for configuration

These parameters are written by the user. They control the internal calculations of the processing unit.

Name	Description	Address	Type	Length	DEC	Value range
Modbus_baud_rate	Modbus serial baud rate	0x30	U32	2	10 <sup>0</sup>	9600, 19200, 38400, 56400, 115200
Flow_rate_max	Maximum flow rate [l/h]	0x32	U32	2	10 <sup>2</sup>	–
Flow_zero_threshold	Threshold for flow rate 0. When the value drops below this limit, the parameter "Avg_Flow_Rate" = 0 is set	0x34	U32	2	10 <sup>2</sup>	–
X_Temperature	Value for temperature compensation [°C]	0x36	I16	1	10 <sup>1</sup>	-40.0 ... +200.0
Avg_Flow_Nb_Samples	Number of measure samples for averaging	0x37	U16	1	10 <sup>0</sup>	–
Flow_Metering_Mode	Revaluation mode: 0 = Volume at X °C 1 = Volume without temperature compensation 2 = Volume as mass [kg]	0x38	U16	1	10 <sup>0</sup>	0, 1, 2
Pulse_Type	Mode of pulse input 0 = Encoder 1 = Counter	0x39	U16	1	10 <sup>0</sup>	0, 1
Density_Determination	Mode of density determination: 0 = Automatic selection of the density table + manual input of the density values 1 = Selection of Density table 1 + manual input of the density values 2 = Selection of Density table 2 + manual input of the density values 3 = Automatic selection of density calculation for diesel or heavy fuel oil 4 = Density calculation for diesel 5 = Density calculation for heavy fuel oil	0x3A	U16	1	10 <sup>0</sup>	0, 1, 2, 3, 4, 5
Temperature_Switch	Switching temperature ("Density_Determination" = 0 or 3): <input type="checkbox"/> Temperature < "Temperature_Switch": Selection of Density table 1 <input type="checkbox"/> Temperature ≥ "Temperature_Switch": Selection of Density table 2	0x3B	I16	1	10 <sup>1</sup>	-40.0 ... +200.0
Density_Reference_1	Density of diesel at 15 °C [kg/m <sup>3</sup> ] (Density_Determination = 3, 4 or 5)	0x3C	U32	2	10 <sup>1</sup>	0.1 ... 80000.0

## 5 Function description

### 5.2 Modbus communication

Name	Description	Address	Type	Length	DEC	Value range
Density_Reference_2	Density of heavy fuel oil at 15 °C [kg/m <sup>3</sup> ] (Density_Determination = 3, 4 or 5)	0x3E	U32	2	10 <sup>1</sup>	0.1 ... 80000.0
Maintenance_Hours	Number of operating hours until the required maintenance	0x4A	U16	1	10 <sup>0</sup>	–

Tab. 14: Parameters for configuration

#### 5.2.7 K-factor table

Name	Description	Address	Type	Length	DEC	Value range
Frequency 1	Frequency 1 [Hz]	0x40	U32	2	10 <sup>3</sup>	0.300 ... 2000.000
Frequency 2	Frequency 2 [Hz]	0x42	U32	2	10 <sup>3</sup>	0.300 ... 2000.000
Frequency 3	Frequency 3 [Hz]	0x44	U32	2	10 <sup>3</sup>	0.300 ... 2000.000
Frequency 4	Frequency 4 [Hz]	0x46	U32	2	10 <sup>3</sup>	0.300 ... 2000.000
Frequency 5	Frequency 5 [Hz]	0x48	U32	2	10 <sup>3</sup>	0.300 ... 2000.000
Frequency 6	Frequency 6 [Hz]	0x4A	U32	2	10 <sup>3</sup>	0.300 ... 2000.000
Frequency 7	Frequency 7 [Hz]	0x4C	U32	2	10 <sup>3</sup>	0.300 ... 2000.000
Frequency 8	Frequency 8 [Hz]	0x4E	U32	2	10 <sup>3</sup>	0.300 ... 2000.000
K-Factor 1	K-factor 1 [pulses/l]	0x50	U32	2	10 <sup>3</sup>	1.000 ... 1000000.000
K-Factor 2	K-factor 2 [pulses/l]	0x52	U32	2	10 <sup>3</sup>	1.000 ... 1000000.000
K-Factor 3	K-factor 3 [pulses/l]	0x54	U32	2	10 <sup>3</sup>	1.000 ... 1000000.000
K-Factor 4	K-factor 4 [pulses/l]	0x56	U32	2	10 <sup>3</sup>	1.000 ... 1000000.000
K-Factor 5	K-factor 5 [pulses/l]	0x58	U32	2	10 <sup>3</sup>	1.000 ... 1000000.000
K-Factor 6	K-factor 6 [pulses/l]	0x5A	U32	2	10 <sup>3</sup>	1.000 ... 1000000.000
K-Factor 7	K-factor 7 [pulses/l]	0x5C	U32	2	10 <sup>3</sup>	1.000 ... 1000000.000
K-Factor 8	K-factor 8 [pulses/l]	0x5E	U32	2	10 <sup>3</sup>	1.000 ... 1000000.000

Tab. 15: K-factor table

## 5.2.8 Density tables

Name	Description	Address	Type	Length	DEC	Value range
Temperature 1.1	Temperature 1 [°C]	0x60	I16	1	10 <sup>1</sup>	-40.0 ... +200.0
Temperature 1.2	Temperature 2 [°C]	0x61	I16	1	10 <sup>1</sup>	-40.0 ... +200.0
Temperature 1.3	Temperature 3 [°C]	0x62	I16	1	10 <sup>1</sup>	-40.0 ... +200.0
Temperature 1.4	Temperature 4 [°C]	0x63	I16	1	10 <sup>1</sup>	-40.0 ... +200.0
Temperature 1.5	Temperature 5 [°C]	0x64	I16	1	10 <sup>1</sup>	-40.0 ... +200.0
Temperature 1.6	Temperature 6 [°C]	0x65	I16	1	10 <sup>1</sup>	-40.0 ... +200.0
Temperature 1.7	Temperature 7 [°C]	0x66	I16	1	10 <sup>1</sup>	-40.0 ... +200.0
Temperature 1.8	Temperature 8 [°C]	0x67	I16	1	10 <sup>1</sup>	-40.0 ... +200.0
Temperature 1.9	Temperature 9 [°C]	0x68	I16	1	10 <sup>1</sup>	-40.0 ... +200.0
Temperature 1.10	Temperature 10 [°C]	0x69	I16	1	10 <sup>1</sup>	-40.0 ... +200.0
Density 1.1	Density 1 [kg/m <sup>3</sup> ]	0x6A	U32	2	10 <sup>1</sup>	0.1 ... 80000.0
Density 1.2	Density 2 [kg/m <sup>3</sup> ]	0x6C	U32	2	10 <sup>1</sup>	0.1 ... 80000.0
Density 1.3	Density 3 [kg/m <sup>3</sup> ]	0x6E	U32	2	10 <sup>1</sup>	0.1 ... 80000.0
Density 1.4	Density 4 [kg/m <sup>3</sup> ]	0x70	U32	2	10 <sup>1</sup>	0.1 ... 80000.0
Density 1.5	Density 5 [kg/m <sup>3</sup> ]	0x72	U32	2	10 <sup>1</sup>	0.1 ... 80000.0
Density 1.6	Density 6 [kg/m <sup>3</sup> ]	0x74	U32	2	10 <sup>1</sup>	0.1 ... 80000.0
Density 1.7	Density 7 [kg/m <sup>3</sup> ]	0x76	U32	2	10 <sup>1</sup>	0.1 ... 80000.0
Density 1.8	Density 8 [kg/m <sup>3</sup> ]	0x78	U32	2	10 <sup>1</sup>	0.1 ... 80000.0
Density 1.9	Density 9 [kg/m <sup>3</sup> ]	0x7A	U32	2	10 <sup>1</sup>	0.1 ... 80000.0
Density 1.10	Density 10 [kg/m <sup>3</sup> ]	0x7C	U32	2	10 <sup>1</sup>	0.1 ... 80000.0

Tab. 16: Parameters of Density table 1

Name	Description	Address	Type	Length	DEC	Value range
Temperature 2.1	Temperature 1 [°C]	0x7E	I16	1	10 <sup>1</sup>	-40.0 ... +200.0
Temperature 2.2	Temperature 2 [°C]	0x7F	I16	1	10 <sup>1</sup>	-40.0 ... +200.0
Temperature 2.3	Temperature 3 [°C]	0x80	I16	1	10 <sup>1</sup>	-40.0 ... +200.0
Temperature 2.4	Temperature 4 [°C]	0x81	I16	1	10 <sup>1</sup>	-40.0 ... +200.0
Temperature 2.5	Temperature 5 [°C]	0x82	I16	1	10 <sup>1</sup>	-40.0 ... +200.0
Temperature 2.6	Temperature 6 [°C]	0x83	I16	1	10 <sup>1</sup>	-40.0 ... +200.0
Temperature 2.7	Temperature 7 [°C]	0x84	I16	1	10 <sup>1</sup>	-40.0 ... +200.0
Temperature 2.8	Temperature 8 [°C]	0x85	I16	1	10 <sup>1</sup>	-40.0 ... +200.0
Temperature 2.9	Temperature 9 [°C]	0x86	I16	1	10 <sup>1</sup>	-40.0 ... +200.0
Temperature 2.10	Temperature 10 [°C]	0x87	I16	1	10 <sup>1</sup>	-40.0 ... +200.0
Density 2.1	Density 1 [kg/m <sup>3</sup> ]	0x88	U32	2	10 <sup>1</sup>	0.1 ... 80000.0
Density 2.2	Density 2 [kg/m <sup>3</sup> ]	0x8A	U32	2	10 <sup>1</sup>	0.1 ... 80000.0
Density 2.3	Density 3 [kg/m <sup>3</sup> ]	0x8C	U32	2	10 <sup>1</sup>	0.1 ... 80000.0
Density 2.4	Density 4 [kg/m <sup>3</sup> ]	0x8E	U32	2	10 <sup>1</sup>	0.1 ... 80000.0
Density 2.5	Density 5 [kg/m <sup>3</sup> ]	0x90	U32	2	10 <sup>1</sup>	0.1 ... 80000.0
Density 2.6	Density 6 [kg/m <sup>3</sup> ]	0x92	U32	2	10 <sup>1</sup>	0.1 ... 80000.0
Density 2.7	Density 7 [kg/m <sup>3</sup> ]	0x94	U32	2	10 <sup>1</sup>	0.1 ... 80000.0
Density 2.8	Density 8 [kg/m <sup>3</sup> ]	0x96	U32	2	10 <sup>1</sup>	0.1 ... 80000.0
Density 2.9	Density 9 [kg/m <sup>3</sup> ]	0x98	U32	2	10 <sup>1</sup>	0.1 ... 80000.0
Density 2.10	Density 10 [kg/m <sup>3</sup> ]	0x9A	U32	2	10 <sup>1</sup>	0.1 ... 80000.0

Tab. 17: Parameters of Density table 2

## 5 Function description

### 5.2 Modbus communication

#### 5.2.9 Error messages

No.	Mask	Error message	Description
1	0x00000001	Alarm 1 – K-factor table: Frequencies not in ascending order	The frequency values in the K-factor table are not all in ascending order.
2	0x00000002	Alarm 2 – Density table: Temperatures not in ascending order	The temperature values in one of the density tables are not all in ascending order.
3	0x00000004	Alarm 3 – Density table: Density values not in descending order	The density values in one of the density tables are not all in descending order.
5	0x00000010	Alarm 5 – K-factor table: Frequency outside the permissible range	At least one frequency value in the K-factor table lies outside the permissible range.
6	0x00000020	Alarm 6 – K-factor table: K-factor outside the permissible range	At least one K-factor value in the K-factor table lies outside the permissible range.
7	0x00000040	Alarm 7 – Density table: Temperature outside the permissible range	At least one temperature value in one of the density tables lies outside the permissible range.
8	0x00000080	Alarm 8 – Density table: Density outside the permissible range	At least one density value in one of the density tables lies outside the permissible range.
9	0x00000100	Alarm 9 – Parameter X_Temperature outside the permissible range	The value of the parameter "X_Temperature" lies below -40 °C or above 200 °C.
10	0x00000200	Alarm 10 – Parameter Flow_Metering_Mode not supported	Impermissible value of the parameter "Flow_Metering_Mode". Possible values are: 0 = Volume at X °C 1 = Volume without temperature compensation 2 = Volume as mass [kg]
11	0x00000400	Alarm 11 – Parameter Pulse_Type not supported	Impermissible value of the parameter "Pulse_Type". Possible values are: 0 = Encoder 1 = Counter
12	0x00000800	Alarm 12 – Parameter Density_Determination not supported	Impermissible value of the parameter "Density_Determination". Possible values are: 0 = Automatic selection of the density table + manual input of the density values 1 = Selection of Density table 1 + manual input of the density values 2 = Selection of Density table 2 + manual input of the density values 3 = Automatic selection of density calculation for diesel or heavy fuel oil 4 = Density calculation for diesel 5 = Density calculation for heavy fuel oil
13	0x00001000	Alarm 13 – Parameter Temperature_Switch outside the valid range	The value of the parameter "Temperature_Switch" lies below -40 °C or above 200 °C.
14	0x00002000	Alarm 14 – Parameter Density_Reference_... outside the valid range	Impermissible reference value for density calculation in Density table 1 or Density table 2.
17	0x00010000	Alarm 17 - Maintenance required	Limit value operating hours until required maintenance is reached.
21	0x00100000	Alarm 21 – Temperature outside the permissible range	Currently measured temperature of the pumped liquid lies below -40 °C or above 200 °C.
22	0x00200000	Alarm 22 – Temperature sensor faulty	Failure or fault of the temperature sensor.
23	0x00400000	Alarm 23 – Device temperature outside the permissible range	The currently measured temperature of the processing unit lies above 105 °C.
29	0x10000000	Alarm 29 – Maximum flow rate exceeded	The current flow rate exceeds the value of the parameter "Flow_Rate_Max".
30	0x20000000	Alarm 30 – Pick up faulty	Failure or fault of a pick up.
31	0x40000000	Alarm 31 – Maximum frequency exceeded	The maximum permissible frequency of the processing unit (4 kHz) is exceeded.
32	0x80000000	Alarm 32 – Device has been restarted	Information message about automatic restart of the processing unit.

Tab. 18: Description of the error messages

**5.2.10 Parameter for clearing error messages**

This parameter can only be written by the user.

Name	Description	Address	Type	Length	DEC
Alarm_Clear	Clearing of an error message from the parameter "Alarm_Read" (0x14) by overwriting with the error-specific mask (see Error messages)	0xC4	U32	2	10 <sup>0</sup>

Tab. 19: Parameter for clearing error messages

**6 Transportation, storage****6.1 Unpacking and checking the state of delivery**

Personnel qualification:	<input type="checkbox"/> Trained personnel
--------------------------	--

1. ► Upon delivery check the product for damage during transportation.
2. ► Report damage during transportation immediately to the manufacturer.
3. ► Dispose of packing material in accordance with the locally applicable regulations.

**6.2 Transporting the electronic unit**

- Transport the electronic unit in the original packaging. Observe ambient conditions in the process  
↳ Technical data, Page 5.

**6.3 Storing the electronic unit**

- Store the electronic unit in the original packaging in a cool and dry place. Observe ambient conditions in the process ↳ Technical data, Page 5.

## 7 Installation, removal

### 7.1 Dangers during installation, removal

## 7 Installation, removal

### 7.1 Dangers during installation, removal



The following safety instructions must be strictly observed:

- Have all work only carried out by electricians.
- Do not take apart the electronic unit.

### 7.2 Installing the processing unit

One processing unit is assigned to exactly one flowmeter. The serial numbers of the processing unit and of the assigned flowmeter are specified on the rating plate of the processing unit ↪ Identification, Page 4.

The processing unit is mounted directly on the flowmeter.

For information on installing the processing unit please refer to the associated operating instructions of the flowmeter.

### 7.3 Removing the processing unit

For information on removing the processing unit please refer to the associated operating instructions of the flowmeter.

## 8 Connection

### 8.1 Dangers during connection work



The following safety instructions must be observed:

- Have all work only carried out by electricians.

### 8.2 Connecting the processing unit

A maximum of 32 processing units can be connected in series. Modbus communication and power supply are effected through a cable. The Modbus input of the last processing unit has to be terminated with a terminating resistor.

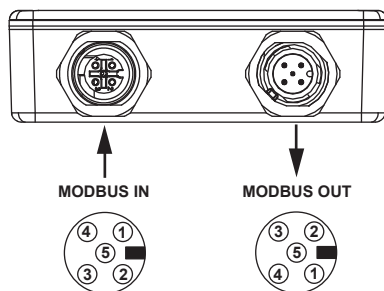

Fig. 5: Pin assignment

Pin	Description
1	Shield
2	DC power supply 10–30 V (+)
3	DC power supply 0 V (- or GND)
4	RS-485 A / + / RXTX-P (positive)
5	RS-485 B / - / RXTX-N (negative) / inverted

Tab. 20: Pin assignment

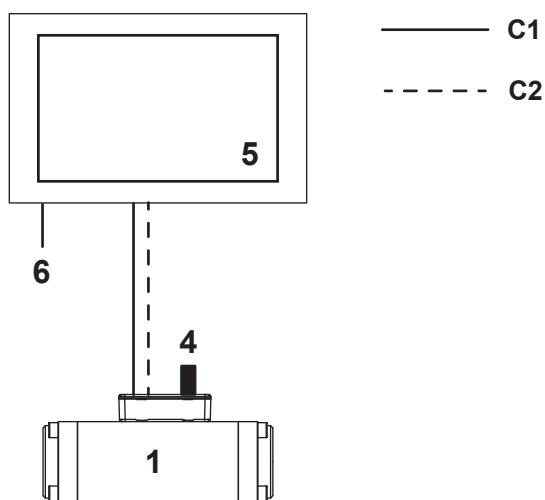

Fig. 6: Connecting one processing unit

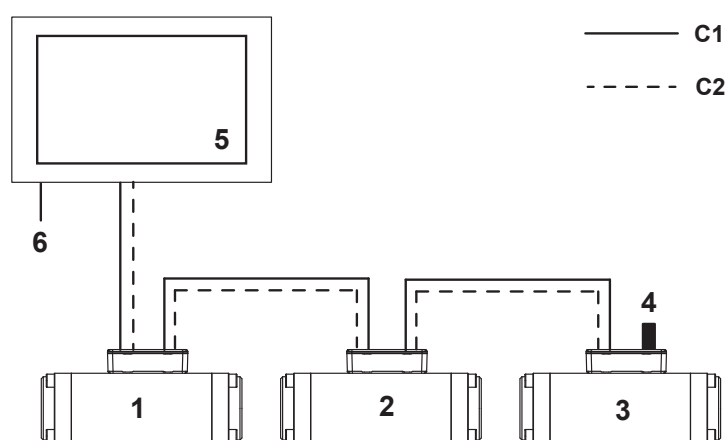

Fig. 7: Connecting several processing units

- |   |                                |    |                              |
|---|--------------------------------|----|------------------------------|
| 1 | Flowmeter with processing unit | 5  | Display device (HMI)         |
| 2 | Flowmeter with processing unit | 6  | Power supply display device  |
| 3 | Flowmeter with processing unit | C1 | Power supply processing unit |
| 4 | Terminating resistor           | C2 | Connection Modbus RS-485     |

## Requirement:

- ✓ Modbus cable available for all the connections

1. ➤ Connect the Modbus output (MODBUS OUT) of the first processing unit with the display device.
2. ➤ Terminate the Modbus input (MODBUS IN) of the last processing unit with the terminating resistor.
3. ➤ When connecting several processing units in series connect the output of a processing unit with the input of the next processing unit.

### 9 Operation

#### 9.1 Carrying out the basic settings

##### 9.1.1 Setting the Modbus address

Modbus addressing is effected by means of two address selector switches on the circuit board of the processing unit.

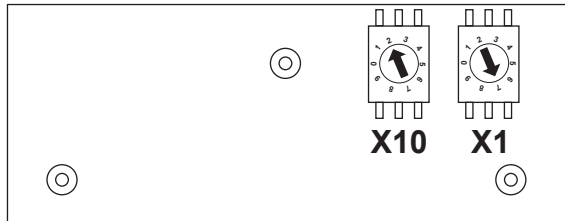

Fig. 8: Modbus addressing

1. ➔ Remove the cover of the processing unit.
2. ➔ Set the Modbus address via the address selector switches **X10** and **X1**.  
Example: For the Modbus address 27 set the address selector switch **X10** to 2 and the address selector switch **X1** to 7.

##### 9.1.2 Managing the density table

###### Parameter "Density\_Determination"

The processing unit offers several possibilities of managing density calculation with the parameter "Density\_Determination".

Two density tables for two different pumped liquids can be stored in the processing unit for the case that the plant is operated with two pumped liquids. If the plant is operated with only one pumped liquid, only one density table is used.

Density determination through	Modbus value
Automatic selection of the density table at manual input of the density values (no density calculation as in Modes 3, 4, 5)	0
Selection of Density table 1	1
Selection of Density table 2	2
Automatic selection of density calculation for diesel or heavy fuel oil	3
Density calculation for diesel (LDO/MDO)	4
Density calculation for heavy fuel oil (HFO)	5

Tab. 21: Parameter "Density\_Determination"



**Entering density values manually**

Density values and temperature values can be entered manually.

—> Set the parameter "Density\_Determination" to 0, 1 or 2 and enter density values.

**Having density values calculated**

In the case of fuel oils the temperature-dependent density values can be calculated automatically from a reference value. The density calculation is implemented in accordance with PTB and DIN 51757 Process B for fuel oils.

—> Set the parameter "Density\_Determination" to 3, 4 or 5.

⇒ The processing unit calculates the density values by using the reference values:

Density table 1 with parameter "Reference\_Density\_1"

Density table 2 with parameter "Reference\_Density\_2"

**Note** After a changeover to calculated density values the processing unit has to be restarted.

**Having a density table selected**

In the case of operation with two different pumped liquids, for example diesel and heavy fuel oil, the selection of the associated density table can be carried out automatically. To this purpose the current temperature of the pumped liquid is compared with the value of the parameter "Temperature\_Switch".

—> For automatic selection of the density table set the parameter "Density\_Determination" to 0 or 3.

⇒ The processing unit compares the currently measured temperature of the pumped liquid with the parameter "Temperature\_Switch" and selects the density table:

Selection of Density table 1 if the temperature is lower than "Temperature\_Switch"

Selection of Density table 2 if the temperature is higher than or equal to "Temperature\_Switch"

**Selecting Density table 1**

—> To select Density table 1 set the parameter "Density\_Determination" to 1 or 4.

**Selecting Density table 2**

—> To select Density table 2 set the parameter "Density\_Determination" to 2 or 5.

**9.1.3 Entering the density table**

The processing unit manages two density tables for two different pumped liquids. The temperature-dependent density values of a pumped liquid are stored in a density table. The calculation of the flow rate at a reference temperature is carried out with the stored values.

If the plant is operated with only one pumped liquid, only one density table is used.

Address	Parameter	Unit	Length	Number of decimal places	Explanation	Data type
0x60 ... 0x69	Temperature 1.1 ... Temperature 1.10	[°C]	1	1	Value x 10	I16
0x6A ... 0x7C	Density 1.1 ... Density 1.10	[kg/m <sup>3</sup> ]	2	1	Value x 10	U32

Tab. 22: Parameters of Density table 1

1. —> Enter the value times 10 in the parameters "Temperature 1.1" to "Temperature 1.10".

**Example:** Entry 125 means 12.5 °C.

2. —> Enter the value times 10 in the parameters "Density 1.1" to "Density 1.10".

**Example:** Entry 8513 means 851.3 kg/m<sup>3</sup>.

#### 9.1.4 Selecting the mode for volume measurement

The parameter "Flow\_Metering\_Mode" is used to control the form in which the processing unit outputs the measured volumes. Three modes are available.

Value	Description
0	Pure measured value, without correction
1	Measured value with temperature compensation
2	Measured value converted into mass [kg]

Tab. 23: Parameter "Flow\_Metering\_Mode"

—> Set the parameter "Flow\_Metering\_Mode" to 0, 1 or 2.

#### 9.1.5 Specifying the reference temperature for temperature compensation

The parameter "X\_Temperature" is used for correction calculation of the density. This correction is called temperature compensation.

The current density of the pumped liquid is calculated by means of the measured temperature of the flowing pumped liquid and of the stored density table. This ensures that measuring errors caused by changes in the density due to temperature variations are avoided.

Value	Description
15	Reference temperature [°C] for correction calculation of the density values (standard value = 15 °C)

Tab. 24: Parameter "X\_Temperature"

—> Enter the reference temperature in the parameter "X\_Temperature".

#### 9.1.6 Smoothing the indication

A strongly fluctuating flow rate causes the jumping display values, making an interpretation by the user difficult. The averaging function reduces this effect by generating an averaging across several measured values.

The following table shows how the number of measured values used for average-value generation affects the response time. The response time is defined as that time in which a jumping change of the pick up frequency (= flow rate) is mapped completely in the parameter "Avg\_Flow\_Rate".

Number of measured values for averaging	Response time [s]
0 or 1	1/16
2	1/8
16	1
100	10
200	20
500	50
1000	100

Tab. 25: Parameter "Avg\_Flow\_Nb\_Samples"

—> Enter the number of measured values for averaging in the parameter "Avg\_Flow\_Nb\_Samples".

#### 9.1.7 Selecting the mode for pulse evaluation

Recognition of the flow direction is controlled via the parameter "Pulse\_Type". Two modes are available.

Value	Description
0	Encoder mode: The processing unit evaluates two pick ups which allows it to recognize the flow direction.
1	Counter mode: The processing unit evaluates only one pick up. A recognition of the flow direction is not possible.

Tab. 26: Parameter "Pulse\_Type"

—> Set the parameter "Pulse\_Type" to 0 or 1.

### 9.1.8 Specifying the maximum flow rate

The maximum flow rate in [l/h] is specified by using the parameter "Maximum\_Flow\_Rate". If the current flow rate exceeds the value specified in the parameter, an error message is output, see "Alarm 29".

→ Enter the desired value times 100 in the parameter "Maximum\_Flow\_Rate".

**Example:** The entry 35500 corresponds to 355.00 l/h.

### 9.1.9 Specifying the minimum flow rate

The minimum flow rate in [l/h] is specified by using the parameter "Flow\_Zero\_Threshold".

This ensures that the flow rate changes to zero after a defined period ( $1/f_{ug}$ ), irrespective of its averaging. If the flow lies below this limit, the average flow rate is set to zero. However, the volume or mass respectively continues to be taken into consideration for the calculation of the total values.

If zero is entered as the limit, the average flow rate only changes to zero after a certain delay. The duration of this delay corresponds to the reaction time of the averaging.

→ Enter the desired value times 100 in the parameter "Flow\_Zero\_Threshold".

**Example:** The entry 5 corresponds to 0.05 l/h.

## 9.2 Reading the measured values and status information

### 9.2.1 Synchronizing measured values

Synchronization between the measurements in the feed and return lines is advisable for the differential measurement. A waiting mode is available to this purpose. This is controlled via the parameter "Hold\_Timer". At an activated waiting mode the current measured values, meaning the automatically updated parameters, are frozen for a specified waiting period.

#### Activating the waiting mode for one processing unit

→ Enter the waiting period in [ms] in the parameter "Hold\_Timer".

⇒ The counter immediately begins to count down. The remaining period of the waiting mode is entered in the parameter "Hold\_Timer". The measured values continue to be updated internally during the waiting period.

#### Activating the waiting mode for several processing units

→ Enter the Modbus address 0 and the waiting period in [ms] in the parameter "Hold\_Timer".

⇒ The parameters "Alarm\_Read", "Total\_Volume\_2", "Avg\_Flow\_Rate", "Temperature" and "Flow\_Dir\_Change" are read.

#### Deactivating the waiting mode

→ Enter the waiting period 0 in the parameter "Hold\_Timer".

#### Increasing the waiting period

→ Before the counter has reached the value zero, enter a new waiting period in [ms] in the parameter "Hold\_Timer".

#### Example:

One set of measured values is to be read per second in a flow rate measuring system with one flowmeter each in the feeder and return line.

1. → Enter a waiting period of 500 ms and the Modbus address 0 in the parameter "Hold\_Timer" so that both processing units can be set simultaneously into the waiting mode.  
The waiting period can be selected freely. A waiting period of 500 ms is sufficient so that the current measured values of the two flowmeters can be read and have expired before the next reading.
2. → Read the measured values from Processing unit 1.  
⇒ Read the parameters "Alarm\_Read", "Total\_Volume\_2", "Avg\_Flow\_Rate", "Temperature" and "Flow\_Dir\_Change" of Processing unit 1.
3. → Read the measured values from Processing unit 2.  
⇒ Read the parameters "Alarm\_Read", "Total\_Volume\_2", "Avg\_Flow\_Rate", "Temperature" and "Flow\_Dir\_Change" of Processing unit 2.
4. → Calculate the quantity and difference of the flow rates.  
⇒ The waiting mode ends automatically after 500 ms.

## 10 Maintenance

### 10.1 Required maintenance

#### 9.2.2 Clearing error messages

Error messages are stored in the parameter "Alarm\_Read". Individual, several or all the error messages can be cleared.

The parameter "Alarm\_Clear" is used to clear error messages. The parameter has to be written with the mask assigned to the error message. The masks of the individual error messages have to be added to clear several error messages.

##### Clearing an error message

—▶ Enter the error message in the parameter "Alarm\_Clear".

**Example:** Error message 3 is to be cleared.

Enter 0x00000004 for Error message 3 in the parameter "Alarm\_Clear".

⇒ If the cause of the error message is not eliminated, the corresponding value is retained in the parameter "Alarm\_Read".

##### Clearing several error messages

—▶ Enter the total of the masks of the error messages in the parameter "Alarm\_Clear".

**Example:** Error messages 3 and 32 are to be cleared.

Enter 0x10000004 (= 0x00000004 for Error message 3 + 0x10000000 for Error message 32) in the parameter "Alarm\_Clear".

⇒ If the causes of the error messages are not eliminated, the corresponding value is retained in the parameter "Alarm\_Read".

##### Clearing all the error messages

—▶ Enter the mask 0xFFFFFFFF in the parameter "Alarm\_Clear".

⇒ If the causes of the error messages are not eliminated, the corresponding value is retained in the parameter "Alarm\_Read".

## 10 Maintenance

### 10.1 Required maintenance

The electronic unit is maintenance-free.

### 10.2 Cleaning the electronic unit

#### ATTENTION

##### Device damage through water.

- ▶ Ensure that no water enters the electronic unit.

—▶ Wipe the housing with a soft cloth. In the case of strong soiling wipe off the housing surface slightly moist with a common detergent.

## 11 Disposal

### 11.1 Disposing of the electronic unit

#### ATTENTION

##### Environmental damage through improper disposal.

- ▶ Dispose of all the components in an environmentally friendly manner in accordance with the applicable local regulations.

➔ As electronic waste the electronic unit has to be disposed of properly.

## 12 Troubleshooting

### 12.1 Status LEDs

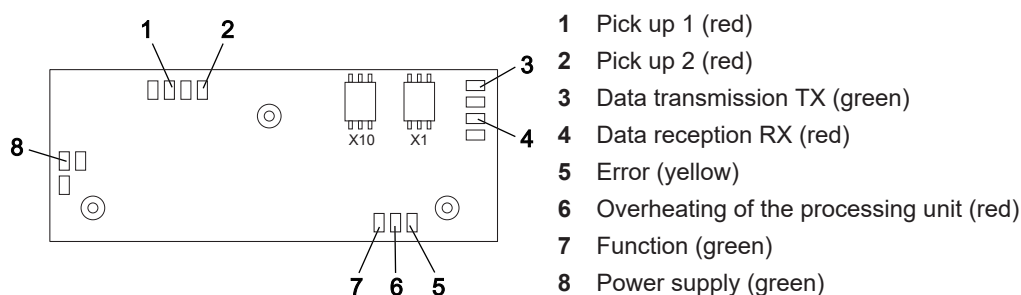

Fig. 9: Status LEDs

### 12.2 Fault table

Fault	Cause	Remedy
Processing unit does not react.	Incorrect Modbus address selected.	1. ➔ Check the Modbus address. 2. ➔ Check the format of the Modbus address.
Processing unit does not react and green LED 8 (power supply) lights up.	Terminating resistor not installed.	➔ Check the connection of the terminating resistor.
Processing unit does not react and green LED 8 (power supply) is off.	Supply defective or incorrect wiring.	➔ Check the power supply.
Processing unit does not react and red LED 4 (data reception) is off.	Processing unit defective or incorrect wiring.	➔ Check the processing unit and/or wiring.
Processing unit does not react and red LED 4 (data reception) flashes.	Data are received but not understood.	➔ Check the terminating resistor, Modbus address and baud rate.
Processing unit indicates the flow in the reverse direction.	Pick ups swapped.	➔ Swop the positions of the pick ups.
Processing unit does not display any flow.	Bypass opened.	➔ Close the bypass.
	Value in the parameter "Flow_Threshold" too high.	➔ Check the parameter "Flow_Threshold" and, if necessary, correct it.
	Flowmeter blocked.	➔ Remove and clean the flowmeter.

Tab. 27: Fault table

### 12.3 Error tree: No communication

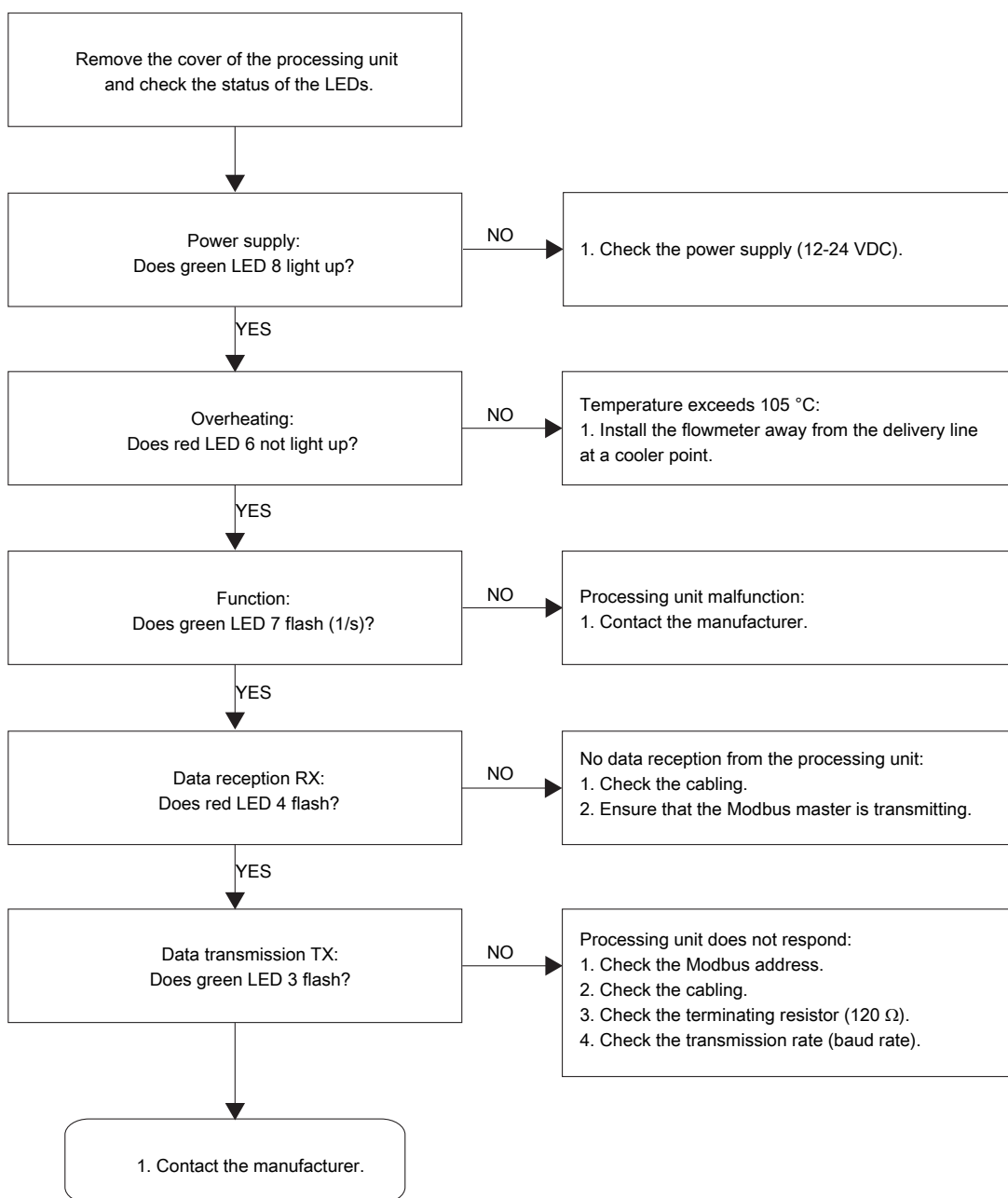

Fig. 10: Error tree: No communication

**12.4 Error tree: No flow**

Fig. 11: Error tree: No flow

**12.5 Error tree: Flow unusually high**

Fig. 12: Error tree: Flow unusually high

**12.6 Error tree: Flow rate varies too much**

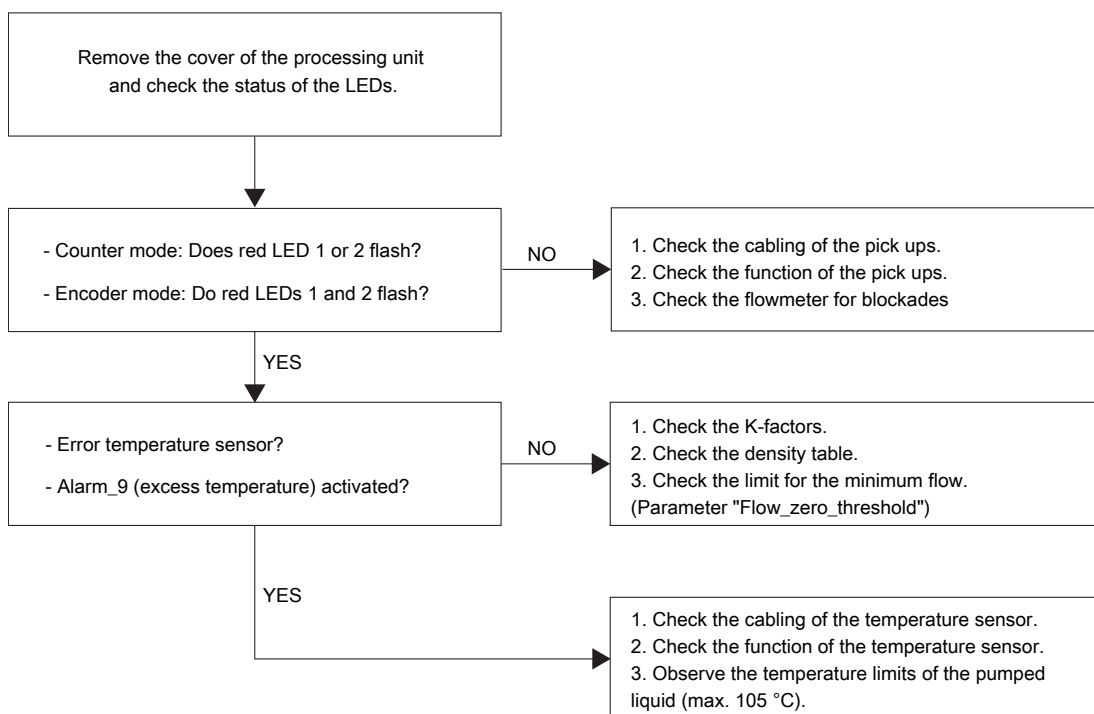
Fig. 13: Error tree: Flow rate varies too much

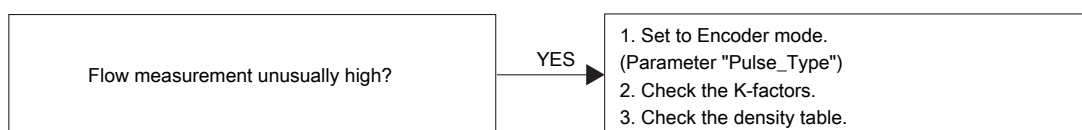

# KRAL

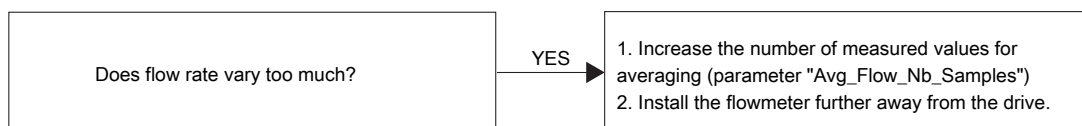