

KRAL flowmeters.

Series OMS
High-viscosity liquids

OIO 31en-GB
Edition 2018-08
Original instructions

1 About this document	3	8.2 Connecting the flowmeter to the pipe system	18
1.1 General information	3	8.3 Connecting the pick up	19
1.2 Target groups	3	9 Operation	20
1.3 Symbols	3	9.1 Dangers during operation	20
1.3.1 Danger levels	3	9.2 Commissioning	20
1.3.2 Danger signs	4	9.2.1 Cleaning the pipe system	20
1.3.3 Symbols in this document	4	9.2.2 Checking the function	20
1.4 Associated documents	4	9.2.3 Commissioning the flowmeter	20
2 Safety	5	9.3 Decommissioning	21
2.1 Proper use	5	9.3.1 Switching off the flowmeter	21
2.2 Foreseeable misuse	5	9.4 Recommissioning	21
2.3 Obligations of the operator-owner	5	9.4.1 Recommissioning the flowmeter	21
2.4 Dangers during transportation	6	10 Maintenance	22
2.5 Dangers during storage	6	10.1 Required maintenance	22
2.6 Dangers during installation	6	10.2 Recalibration of the flowmeter	22
2.7 Dangers during removal	6	11 Disposal	22
2.8 Dangers during connection work	6	11.1 Dangers during disposal	22
2.9 Dangers during operation	6	11.2 Dismantling and disposing of the flowmeter	22
2.10 Dangers during servicing	7	12 Troubleshooting	24
2.11 Dangers during disposal	7	12.1 Possible faults	24
3 Identification	8	12.2 Troubleshooting	24
3.1 Type code	8	13 Appendix	26
3.2 Rating plate	8	13.1 Tightening torque for screws with metric screw threads and head contact surfaces	26
4 Technical data	9	13.2 Tightening torques for screw plugs with thread meas- ured in inches and elastomer seal	26
4.1 Operating limits	9	13.3 Contents of the Declaration of Conformity	26
4.2 Pressure pulsation	9		
4.3 Maximum values	9		
4.4 Pick up	9		
4.5 Pin assignment / Connection diagram	10		
4.6 Dimensions and weights	10		
4.6.1 Pipe thread (BSPP thread)	10		
5 Function description	11		
5.1 Structure	11		
5.2 Functional principle	11		
5.3 Signal generation	11		
5.4 Recognition of flow direction	12		
5.5 Temperature compensation (optional)	12		
6 Transportation, storage	12		
6.1 Dangers during storage	12		
6.2 Unpacking and checking the state of delivery	12		
6.3 Transporting flowmeters	12		
6.4 Storing the flowmeter	12		
7 Installation, removal	13		
7.1 Dangers during installation	13		
7.2 Dangers during removal	13		
7.3 Installing the flowmeter	13		
7.3.1 Protecting the flowmeter against soiling	13		
7.3.2 Installation types	14		
7.3.3 Installation recommendation	15		
7.3.4 Installing the flowmeter	16		
7.4 Installing the trace heating (optional)	16		
7.5 Removing the flowmeter	17		
8 Connection	18		
8.1 Dangers during connection work	18		

1 About this document

1.1 General information

These instructions form part of the product and must be kept for future reference. Furthermore please observe the associated documents.

1.2 Target groups

The instructions are intended for the following persons:

- Persons who work with the product
- Operator-owners who are responsible for the use of the product

Information on the required qualification of the personnel is provided separately at the beginning of the individual chapters in these instructions. The following table provides an overview.

Target group	Activity	Qualification
Transport personnel	Transportation, unloading	Transport personnel are qualified personnel who carry out the transportation of products properly due to their training, knowledge and experience and on the basis of the relevant provisions. Transport personnel recognize and avoid possible dangers and damage to property that are connected with this activity.
Mobile crane operators, crane operators, forklift operators	Unloading, positioning	Mobile crane operators, crane operators and forklift operators are qualified personnel who carry out work with cranes and forklifts properly due to their training, knowledge and experience and on the basis of the relevant provisions. Mobile crane operators, crane operators and forklift operators recognize and avoid possible dangers and damage to property that are connected with this activity.
Fitter	Mounting, connection	Fitters are qualified personnel who carry out the mounting work properly due to their training, knowledge and experience and on the basis of the relevant provisions. Fitters recognize and avoid possible dangers and damage to property that are connected with this activity.
Electrician	Electrical connection	Electricians are qualified personnel who carry out work on electrical equipment and installations properly due to their training, knowledge and experience and on the basis of the relevant provisions. Electricians recognize and avoid possible dangers and damage to property that are connected with this activity.
Trained personnel	Delegated task	Trained personnel were instructed by the operator-owner in the task delegated to them and the possible dangers arising through improper behaviour.

Tab. 1: Target groups

1.3 Symbols







1.3.1 Danger levels

	Signal word	Danger level	Consequences of non-observance
	DANGER	Immediate threat of danger	Serious personal injury, death
	WARNING	Possible threat of danger	Serious personal injury, invalidity
	CAUTION	Potentially dangerous situation	Slight personal injury
	ATTENTION	Potentially dangerous situation	Material damage







1 About this document

1.4 Associated documents

1.3.2 Danger signs

	Meaning	Source and possible consequences of non-observance
	Electrical voltage	Electrical voltage causes serious physical injury or death.
	Raised load	Falling objects can result in serious physical injury or death.
	Heavy load	Heavy loads can result in serious back problems.
	Risk of slipping	Discharging pumped liquid and oils on the foundation or tread surfaces can cause falls with serious physical injury or death.
	Flammable substances	Discharging pumped liquid and oils can be easily inflammable and can result in serious burns.
	Hot surface	Hot surfaces can cause burns.

1.3.3 Symbols in this document

	Meaning
	Warning personal injury
	Safety instruction
	Request for action
	Multi-step instructions for actions
	Action result
	Cross-reference

1.4 Associated documents

- Calibration certificate (optional)
- Declaration of conformity according to EU Directive 2006/42/EC
- Manufacturer's declaration according to EU Directive 2014/68/EU
- Corresponding operating instructions for accessories

2 Safety

2.1 Proper use

- Use the flowmeter solely for measuring the flow of liquids that do not contain any gas components or solid particles.
- If coarse soiling, solid particles in the liquid or abrasive fine particles occur during operation, the flowmeter has to be protected additionally by a correspondingly dimensioned operating filter in the pipe system.
- Use the flowmeter only within the operating limits specified on the rating plate and in the chapter "Technical data". Deviating operating data can result in damage to the flowmeter. In the case of operating data that do not agree with the specifications on the rating plate, please contact the manufacturer.
- Strong changes in the flow rate (for example rapid shutdown, pulsations, etc.) cause marked pressure differences in the flowmeter and can damage the measuring unit. The pressure loss of the flowmeter must not exceed the values shown in the chapter "Technical data".

2.2 Foreseeable misuse

- Any use that extends beyond the proper use or any other use is misuse.
- The product is not suitable for pumping liquids outside the operational limits.
- Any bypassing or deactivation of safety equipment during operation is prohibited.

2.3 Obligations of the operator-owner

The operator-owner is the person who operates the product commercially or permits a third party to use it and who bears the legal responsibility for the product, the protection of the personnel and third parties during its operation.

The product is used in industrial applications. The operator-owner is therefore subject to the statutory obligations concerning occupational health and safety.

In addition to the safety instructions in these instructions, the regulations on safety, accident prevention and environmental protection respectively valid for the range of application of the product are to be observed.

This results in the following obligations for the operator-owner:

- Observe the rules and regulations such as national standards, international standards and provisions applicable at the site of use.
- Observe the obligations arising from occupational safety and from safety, accident protection and environmental protection.
- Draw up a hazard assessment for the utilization of the product at the site of use.
- Draw up the operating guidelines for the operation of the product on the basis of the hazard assessment.
- Keep the operating guidelines up-to-date during the entire operating life of the product, by ensuring that the current version of the applicable rules and regulations are integrated.
- Ensure the qualification, instruction, information on dangers as well as regular training of the personnel.
- Specify clear responsibilities for all work on the product, for example for the installation, operation, maintenance, troubleshooting.
- Keep the operating instructions available at the site of use - also for future use.
- Ensure that the operating instructions as well as the associated documents are read, understood and observed by the personnel.
- Observe the safety regulations for handling dangerous pumped liquids and comply with the safety data sheets. Pumped liquids can, for example, be hot, poisonous, combustible and caustic.
- Make personal protective equipment available and instruct their use.
- Equip systems with an increased potential of danger with protective equipment and/or alarm equipment. The failure of a component may not result in injury and/or damage to property.
- Maintain and check protective equipment and alarm equipment regularly.
- Ensure the technically flawless state of the product during its entire operating life.

2.4 Dangers during transportation



The following safety instructions must be observed:

- Have all work only carried out by authorized transport personnel.
- Use intact and correctly dimensioned hoisting equipment.
- Ensure that the means of transport is in a flawless state.
- Ensure that the centre of gravity of the load is taken into consideration.
- Do not stand under raised loads.

2.5 Dangers during storage



The following safety instructions must be observed:

- Observe the storage conditions.

2.6 Dangers during installation



The following safety instructions must be observed strictly:

- Have all work only carried out by authorized qualified personnel.
- Do not take apart the flowmeter.

2.7 Dangers during removal



The following safety instructions must be observed strictly:

- Have all work only carried out by authorized qualified personnel.
- Ensure that the collection tank for emitted liquids is sufficiently large.
- Collect any discharging pumped liquid safely and dispose of it in an environmentally compatible manner in accordance with the applicable local regulations.

2.8 Dangers during connection work



The following safety instructions must be observed strictly:

- Have all the work on the flowmeter and pipe system only carried out by authorized qualified personnel.
- Ensure that solid particles cannot get into the flowmeter and pipe system.
- Ensure that mechanical connections are mounted free of stress.
- Observe the tightening torques.
- Have all the work on the electrical equipment only carried out by electricians.
- Before beginning work on the flowmeter ensure that the electrical power supply is deenergized and is secured against being switched back on.
- If the insulation of the electrical cables or wires is damaged, disconnect the power supply immediately.
- The connecting line of the pick up/temperature sensor connection is to be shielded and laid separately from the supply lines.

2.9 Dangers during operation



The following safety instructions must be observed strictly:

- Have all work only carried out by authorized qualified personnel.
- Ensure that the flowmeter is only operated within the operating limits.
- Ensure that during cooling down or heating up the flowmeter is only subjected to slow temperature changes.
- Ensure that existing safety equipment is not bypassed or activated during operation.

2.10 Dangers during servicing

**The following safety instructions must be observed strictly:**

- Have all work only carried out by authorized qualified personnel.
- To ensure the measuring precision, the measuring unit may only be replaced by the manufacturer.
- Before beginning work, let the flowmeter cool down slowly to the ambient temperature. Avoid rapid temperature changes.
- Pumped liquids can be hot, poisonous, combustible and caustic.
- Observe the tightening torques ↗ Appendix, Page 26.
- Observe the operating instructions and data sheets of the sensors.

2.11 Dangers during disposal

**The following safety instructions must be observed strictly:**

- Collect any discharging pumped liquid safely and dispose of it in an environmentally compatible manner in accordance with the applicable local regulations.
- Ensure that the collection tank for emitted liquids is sufficiently large.
- Neutralize residues.

3 Identification

3.1 Type code

3 Identification

3.1 Type code

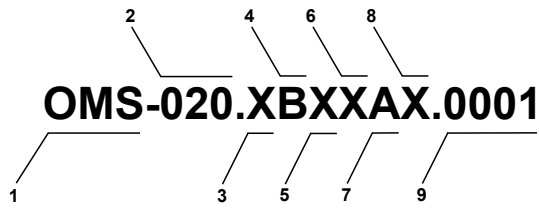

Fig. 1: Type code

- 1 Series
- 2 Size
- 3 Sensor equipment (pick up)
- 4 Function of the sensor equipment
- 5 Material of bearing
- 6 Material of seal
- 7 Mechanical connection
- 8 Electrical connection
- 9 Version index

Item	Designation	Description	
1	Series	OMS	Stainless steel
2	Size		Corresponds to the diameter of the large measuring screw in [mm]
3	Sensor equipment (pick up)	X	Special design
4	Function of the sensor equipment	B	With recognition of flow direction
		D	With recognition of flow direction, with temperature compensation
		X	Special design
5	Material of bearing	X	Special design
6	Material of seal	X	Special design
7	Mechanical connection	A	Thread connection BSPP
		B	Flange connection DIN
		C	Thread connection NPT
		D	Flange connection ANSI
		E	Flange connection JIS
		F	Flange connection SAE
		X	Special design
8	Electrical connection	X	Special design
9	Version index		For internal administration

Tab. 2: Type code

3.2 Rating plate

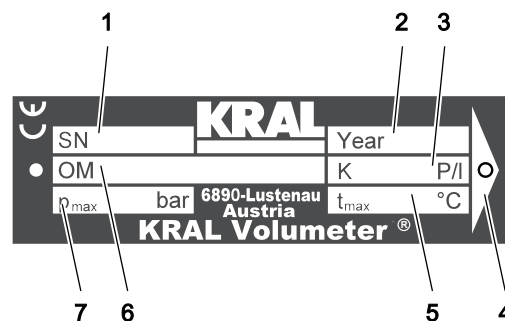

Fig. 2: Rating plate

- 1 Serial number
- 2 Construction year
- 3 K-factor
- 4 Preferred flow direction
- 5 Max. temperature
- 6 Series
- 7 Max. pressure

4 Technical data

4.1 Operating limits

The values specified on the rating plate apply, as well as the values on the calibration certificate if the optional calibration of the flowmeter was ordered.

The permissible operating limits of individual values influence each other so that every application is checked individually by the manufacturer when selecting the flowmeter.

If no operating data are provided by the orderer, standardized substitute operating data are used.

4.2 Pressure pulsation

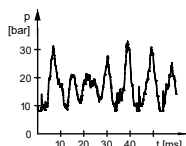

Fig. 3: Pressure pulses

Strong pressure pulsations in the system can reduce the service life of the flowmeter.

4.3 Maximum values

The following table shows the respective maximum values that, however, may not occur simultaneously. In addition, the operating limits of the corresponding completion, of the sealing material and of the pick up are to be observed.

	Unit	OMS-020
Flow rate		
Q_{rated}	[l/min]	10
Q_{min}	[l/min]	0.04
Max. pressure	[bar]	400
Temperature		
min - max	[°C]	-20 ... +80
Viscosity		
min - max	[mm ² /s]	10 ² – 10 ⁶
K-factor	[P/l]	66000

Tab. 3: Maximum values

4.4 Pick up

	Unit	OMS-020
Supply voltage U_B	[VDC]	10 – 29
Closed current	[mA]	< 20
Frequency range	[Hz]	44 – 11000 (with K-factor 66000 P/l)
Electrical connection		M12 socket connector, 5-pole, A-coding
Output		Push-pull, driver stages
Short-circuit-proof		Yes
Output current limiting	[mA]	30 (per output)
Output low level	[V]	< 0.5 (@ 1 mA), 1 (@10 mA)
Output high level	[V]	$U_{\text{high}} > 22.5$ (@ $U_b = 24$ V, 1 mA) $U_{\text{high}} > 22.0$ (@ $U_b = 24$ V, 10 mA)
Degree of protection		IP 67

Tab. 4: Pick up

4 Technical data

4.5 Pin assignment / Connection diagram

4.5 Pin assignment / Connection diagram

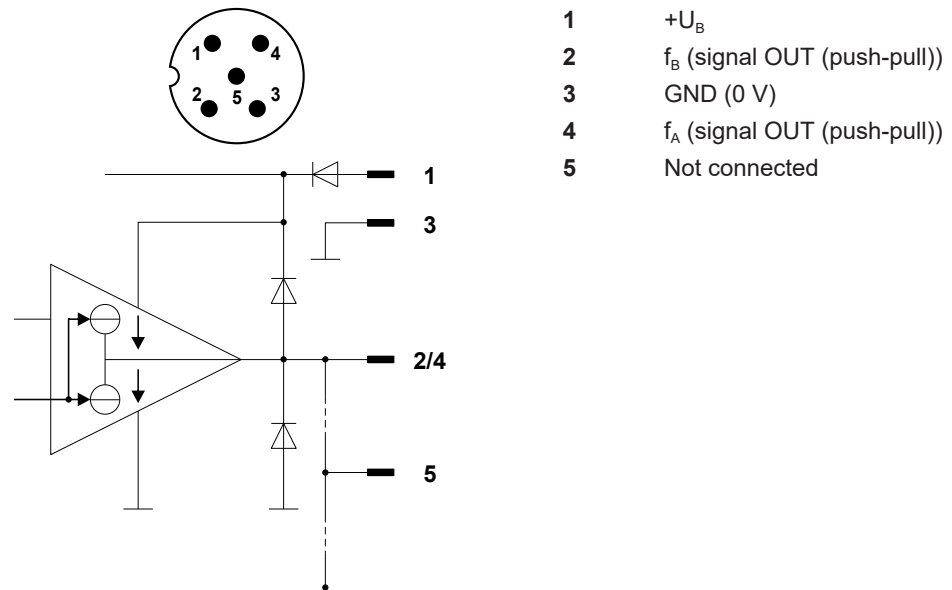

Fig. 4: Pin assignment / Connection diagram

4.6 Dimensions and weights

4.6.1 Pipe thread (BSPP thread)

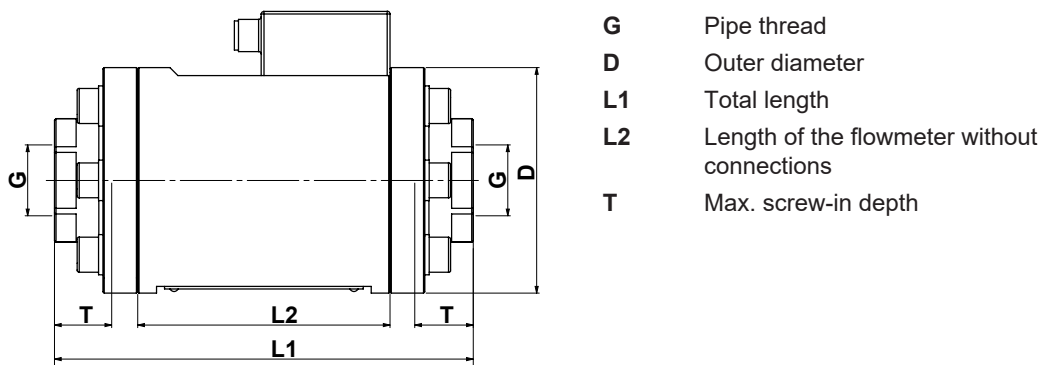

Fig. 5: Dimensional drawing pipe thread

	Unit	OMS-020
G	[inch]	3/4
Pressure stage	[bar]	400
D	[mm]	84
L1	[mm]	156
L2	[mm]	94
T	[mm]	21
Weight	[kg]	6.0

Tab. 5: Dimensions and weights - pipe thread connection

5 Function description

5.1 Structure

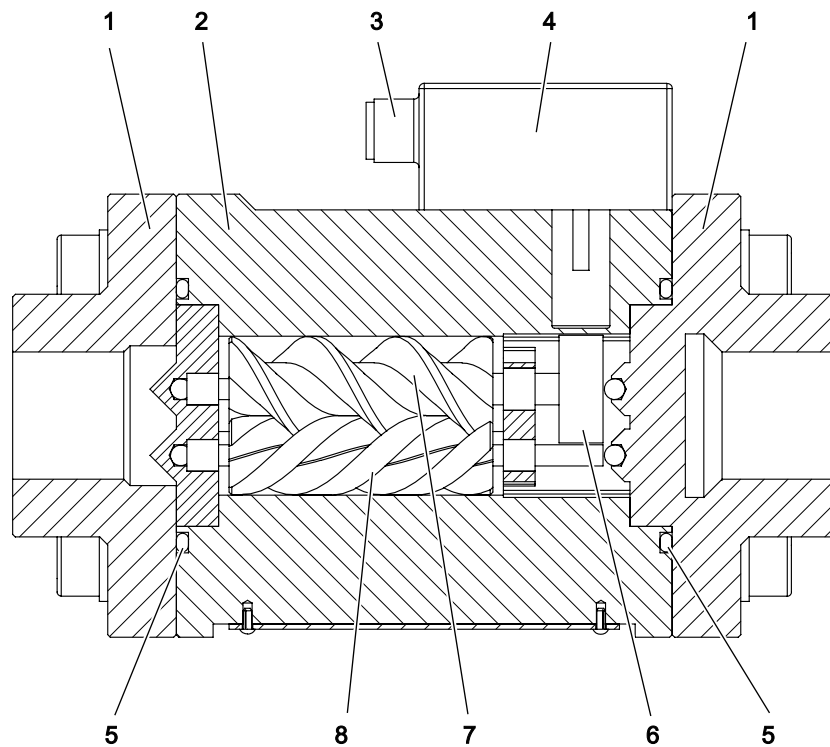

Fig. 6: Structure of the flowmeter

1	Connection mechanical	5	O-ring
2	Measuring housing	6	Pole wheel
3	Connection electrical	7	Measuring screw large
4	Pick-up	8	Measuring screw small

5.2 Functional principle

Flowmeters belong to the group of rotating displacement meters as screw meters. The pumped liquid makes the measuring unit rotate. The displacement effect results from the continuous filling, axial displacement and discharge of the volumes that are formed by the measuring housing and measuring unit. The measured pumped liquid flows around and lubricates all the rotating parts. Thanks to the displacement principle, the flowmeter does not require inlet sections and smoothing sections at the feed line and outlet.

Depending on the customer requirements, the flowmeters can be equipped with suitable end connections for connection to various flanges.

5.3 Signal generation

A pole wheel **6** whose pole is sampled by a pick up **4** is affixed at the end of the large measuring screw **7**. This pick up generates a specific number of pulses per flow volume unit - depending on the size and working point. This device-specific characteristic is called the K-factor (unit: Pulse/litre) and is specified on the rating plate as well as the optional calibration certificate.

The preferred flow direction is specified on the rating plate and on the measuring housing **2** of the flowmeter. When this flow direction is observed, the pick up is located on the low-pressure end (outlet) in the case of blocking.

6 Transportation, storage

5.4 Recognition of flow direction

5.4 Recognition of flow direction

In the case of systems with pressure pulsation a reversal of the flow direction can occur briefly. In order to recognize the flow direction the flowmeter is equipped with a two-channel pick up. The flow direction can be determined by means of the additional phase-shifted signal and then taken into account for the calculation of the total values.

5.5 Temperature compensation (optional)

Flowmeters of the series OMS can additionally be equipped with a temperature sensor. The current density of the flowing liquid can be calculated from the measured values of the temperature sensor by using a density table stored in an external evaluation electronic unit. This allows standardised volume measurement in which the displayed values are converted to a reference temperature that can be selected freely. This ensures that measuring errors caused by changes in the density due to temperature variations are avoided.

6 Transportation, storage

6.1 Dangers during storage



The following safety instructions must be observed:

- Observe the storage conditions.

6.2 Unpacking and checking the state of delivery

1. ➤ Upon delivery unpack the flowmeter and check it for damage during transportation.
2. ➤ Report damage during transportation immediately to the manufacturer.
3. ➤ Dispose of packaging material in accordance with the locally applicable regulations.

6.3 Transporting flowmeters

ATTENTION

Damage to equipment through improper transportation.

- ▶ Protect the flowmeter against damage, heat, sunlight, dust and moisture.

➤ Transport the flowmeter in the original packaging.

6.4 Storing the flowmeter

The connections of the flowmeter are fitted with protective covers before being dispatched.

ATTENTION

Damage to equipment and corrosion if stored improperly and during longer standstills.

- ▶ Protect the flowmeter against damage, heat, sunlight, dust and moisture.
- ▶ Observe measures for storage.

➤ Store cool and dry and protect against sunlight.

7 Installation, removal

7.1 Dangers during installation



The following safety instructions must be observed strictly:

- Have all work only carried out by authorized qualified personnel.
- Do not take apart the flowmeter.

7.2 Dangers during removal



The following safety instructions must be observed strictly:

- Have all work only carried out by authorized qualified personnel.
- Ensure that the collection tank for emitted liquids is sufficiently large.
- Collect any discharging pumped liquid safely and dispose of it in an environmentally compatible manner in accordance with the applicable local regulations.

7.3 Installing the flowmeter

7.3.1 Protecting the flowmeter against soiling

Notice Soiling in the pipe system impairs the service life of the flowmeter. In order to protect the flowmeter against soiling the manufacturer generally recommends the installation of an operating filter.

Personnel qualification:	<input type="checkbox"/> Fitter
Personal protective equipment:	<input type="checkbox"/> Work clothing <input type="checkbox"/> Protective gloves <input type="checkbox"/> Safety boots

ATTENTION

Damage to device through solid particles in the pipe system.

- ▶ During welding work attach protective covers in front of the connecting flanges.
- ▶ Ensure when welding that welding beads and abrasive dust cannot get into the pipe system and the flowmeter.
- ▶ Ensure that an operating filter is installed when the pipe system is flushed and cleaned using the flowmeter.

1. ▶ Install the operating filter in front of the flowmeter, mesh width ↗ Commissioning, Page 20.
2. ▶ After the connecting work clean the pipe system thoroughly ↗ Commissioning, Page 20.

7.3.2 Installation types

Flowmeters can be operated in different mounting positions.

Both flow directions are possible. The preferred flow direction is indicated on the rating plate by means of a bright arrow → Identification, Page 8.

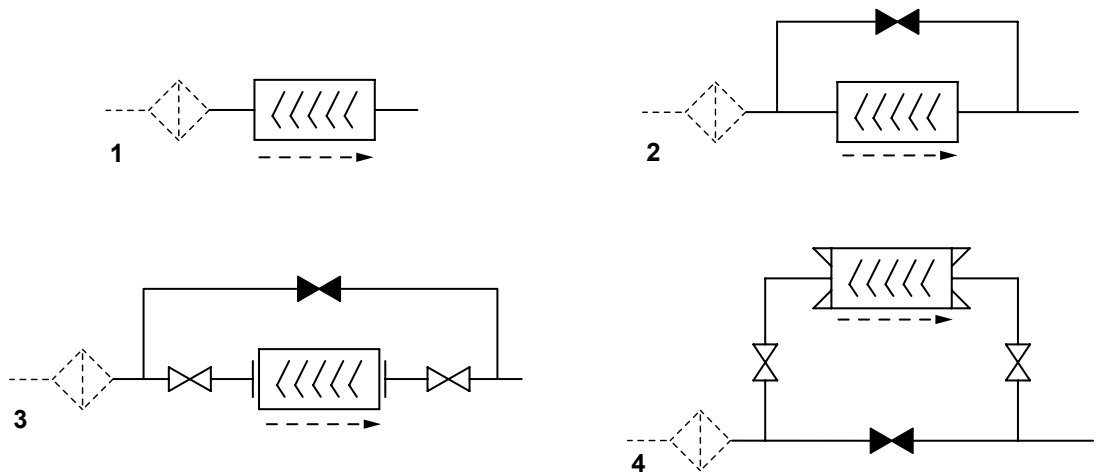

Fig. 7: Installation types

The arrow with dashed line identifies the preferred flow direction when an operating filter is used.

	Installation type	Properties
1	<input type="checkbox"/> Without bypass <input type="checkbox"/> With or without operating filter	<input type="checkbox"/> Small space requirements <input type="checkbox"/> Dismantling of the flowmeter only with operation interruption
2	<input type="checkbox"/> Manual bypass <input type="checkbox"/> With or without operating filter	<input type="checkbox"/> Manual opening of the bypass <input type="checkbox"/> Dismantling of the flowmeter only with operation interruption
3	<input type="checkbox"/> Bypass with 3 shut-off valves for flange connection <input type="checkbox"/> With or without operating filter	<input type="checkbox"/> Dismantling of the flowmeter without operation interruption
4	<input type="checkbox"/> Bypass with 3 shut-off valves for pipe thread connection <input type="checkbox"/> With or without operating filter	<input type="checkbox"/> Dismantling of the flowmeter without operation interruption <input type="checkbox"/> Minimal higher pressure loss

Tab. 6: Installation types

7.3.3 Installation recommendation

In order to avoid measuring errors observe the following recommendations of the manufacturer when installing the flowmeter in the pipe system.

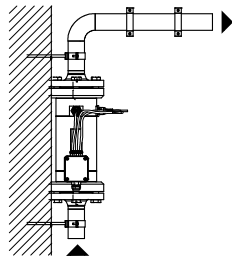

Preferred installation variant:

- Install the flowmeter vertically.
- Route the flow from the bottom upwards.

Recommendations for alternative installation variants

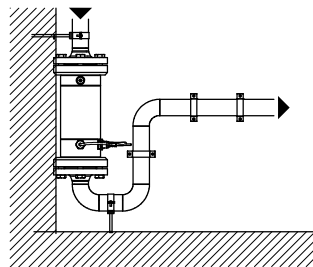

Alternative installation variant:

- Install the flowmeter vertically.
- Route the flow from the top downwards.
- Route the piping at the outlet upwards.

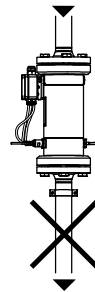

Source for measuring error:

- Lack of counter-pressure at the outlet through downward routing of the piping.

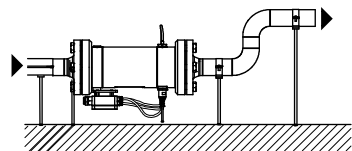

Alternative installation variant:

- Install the flowmeter horizontally.
- Route the piping at the outlet upwards.

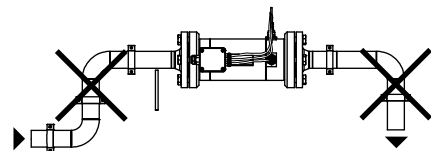

Source for measuring error:

- Formation of an air pocket through the installation of the flowmeter at the highest point of the piping.

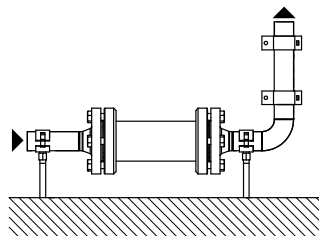

Recommendation:

- Carefully vent the pipe system during commissioning.

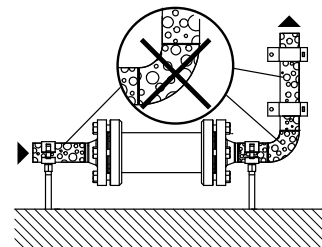

Source for measuring error:

- Gas inclusions in the pipe system

7 Installation, removal

7.4 Installing the trace heating (optional)

7.3.4 Installing the flowmeter

Personnel qualification:	<input type="checkbox"/> Fitter
Personal protective equipment:	<input type="checkbox"/> Work clothing <input type="checkbox"/> Protective gloves <input type="checkbox"/> Safety boots

ATTENTION

Measuring error through air pocket in the flowmeter.

- ▶ During installation ensure that the flowmeter is not installed at the highest point in the pipe system.

ATTENTION

Measuring error through a lack of counter-pressure.

- ▶ During the installation ensure that the piping at the outlet of the flowmeter runs upwards or that the pipe diameter is reduced through a reducer so that the liquid generates a counter-pressure.

- ▶ During the installation of the flowmeter observe the recommendations for the installation variants and avoid error sources.

7.4 Installing the trace heating (optional)

The flowmeter can optionally be equipped with a trace heating system provided by the customer. The manufacturer recommends a heating system at high-viscosity liquids that do not flow sufficiently if not heated.

Notice Before installing trace heating provided by the customer, contact the manufacturer.

Personnel qualification:	<input type="checkbox"/> Fitter
Personal protective equipment:	<input type="checkbox"/> Work clothing <input type="checkbox"/> Protective gloves <input type="checkbox"/> Safety boots

ATTENTION

Defective components through the maximum temperature being exceeded.

- ▶ Do not heat the pick ups, socket connectors and connecting cables above the maximum permissible temperature ↪ Technical data, Page 9.

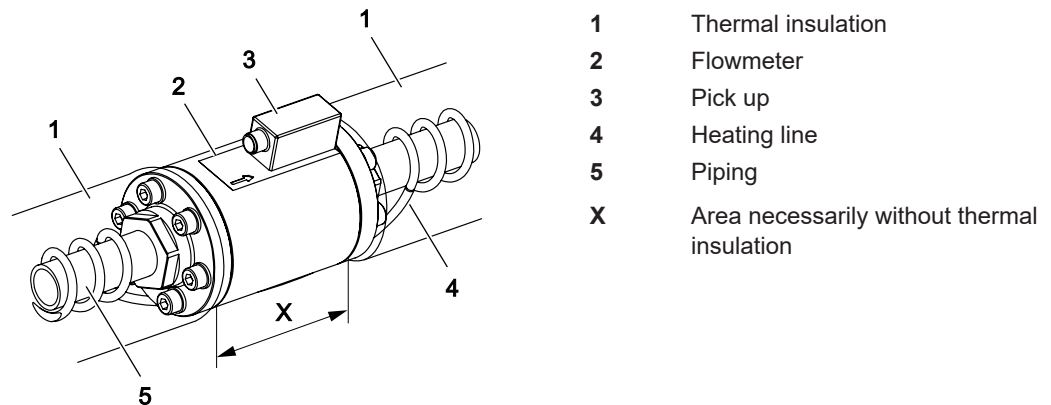

Fig. 8: Flowmeter with trace heating

- ▶ Wind the heating line 4 around the piping 5. Ensure that the pick up 3, junction box and associated cables are not thermally insulated. The area X must remain free of thermal insulation.

7.5 Removing the flowmeter

Personnel qualification:	<input type="checkbox"/> Fitter <input type="checkbox"/> Electrician
Personal protective equipment:	<input type="checkbox"/> Work clothing <input type="checkbox"/> Face protection <input type="checkbox"/> Protective gloves <input type="checkbox"/> Safety boots
Aids:	<input type="checkbox"/> Collection tank



DANGER

Risk of death resulting from electric shock.

- ▶ Ensure that the electrical power supply is de-energized and is secured against being switched back on.
- ▶ Observe the operating instructions of the electrical components.



DANGER

Risk of death through emitted pumped liquid.

Pumped liquids can be hot, poisonous, combustible and caustic and can spray out under high pressure.

- ▶ Wear personal protective equipment during all the work. Ensure face protection.
- ▶ Before beginning work, let the flowmeter cool down to the ambient temperature.
- ▶ Ensure that the flowmeter is depressurized.
- ▶ Collect any discharging pumped liquid safely and dispose of it in an environmentally compatible manner in accordance with the applicable local regulations.

Requirement:

- ✓ System switched off
 - ✓ Disconnect the system from the power supply and secure it against being switched back on
 - ✓ Flowmeter cooled down to the ambient temperature
1. ▶ Drain the pipe system or divert the pumped liquid via bypass.
 2. ▶ Remove the flowmeter.
 3. ▶ Attach protective covers in front of connecting flanges.
 4. ▶ For storage of the flowmeter ↪ Transportation, storage, Page 12.

8 Connection

8.1 Dangers during connection work



The following safety instructions must be observed strictly:

- Have all the work on the flowmeter and pipe system only carried out by authorized qualified personnel.
- Ensure that solid particles cannot get into the flowmeter and pipe system.
- Ensure that mechanical connections are mounted free of stress.
- Observe the tightening torques.
- Have all the work on the electrical equipment only carried out by electricians.
- Before beginning work on the flowmeter ensure that the electrical power supply is deenergized and is secured against being switched back on.
- If the insulation of the electrical cables or wires is damaged, disconnect the power supply immediately.
- The connecting line of the pick up/temperature sensor connection is to be shielded and laid separately from the supply lines.

8.2 Connecting the flowmeter to the pipe system

Personnel qualification:	<input type="checkbox"/> Fitter
Personal protective equipment:	<input type="checkbox"/> Work clothing <input type="checkbox"/> Protective gloves <input type="checkbox"/> Protective helmet <input type="checkbox"/> Safety boots
Aids:	<input type="checkbox"/> Hoisting equipment

ATTENTION

Damage to device through mechanical stress.

- ▶ Ensure that the flowmeter is mounted free of mechanical stresses in the pipe system.
- ▶ Observe the tightening torques.

ATTENTION

Damage to device through solid particles in the pipe system.

- ▶ During welding work attach protective covers in front of the connecting flanges.
- ▶ Ensure when welding that welding beads and abrasive dust cannot get into the pipe system and the flowmeter.
- ▶ Ensure that an operating filter is installed when the pipe system is flushed and cleaned using the flowmeter.

ATTENTION

Damage to device when the pipe threading is screwed in too far.

- ▶ Observe the thread length of the flowmeter.
- ▶ Use a standard cutting ring screw connection.

Notice The screw-in length of the piping may not exceed the threaded length of the flowmeter, since the flow cross-section is narrowed and internal components can be damaged.

1. ➤ Remove the protective covers and store them.
2. ➤ Place the piping in position and support the weight of the piping.
3. ➤ Install the flowmeter stress-free into the pipe system. In the process take the preferred flow direction into account and ensure that the connections of the pick up remain accessible.

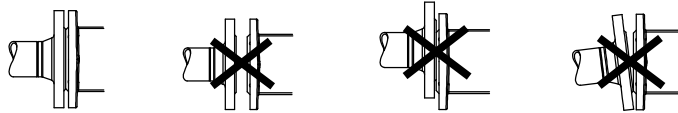

4. ➤ Check the linear offset, lateral offset and angular offset and correct if necessary. If the screws tighten easily, this is a sure sign that the installation is stress-free.
5. ➤ Tighten the connecting screws crosswise with torque ↪ Appendix, Page 26.

8.3 Connecting the pick up

The flowmeter is equipped with a two-channel pick up.

1. ➤ Connect the pick up with a 5-pin socket connector. Take the pin assignment into account ↪ Technical data, Page 9.
2. ➤ Tighten the fastening screw at socket connector only hand-tight.
3. ➤ Earth the flowmeter carefully.

9 Operation

9.1 Dangers during operation



The following safety instructions must be observed strictly:

- Have all work only carried out by authorized qualified personnel.
- Ensure that the flowmeter is only operated within the operating limits.
- Ensure that during cooling down or heating up the flowmeter is only subjected to slow temperature changes.
- Ensure that existing safety equipment is not bypassed or activated during operation.

9.2 Commissioning

9.2.1 Cleaning the pipe system

Notice Soiling in the pipe system impairs the service life of the flowmeter. In order to protect the flowmeter against soiling the manufacturer generally recommends the installation of an operating filter.

ATTENTION

Damage to device through usage of an incorrect flushing liquid.

- ▶ Under no circumstances may water or superheated steam be used to flush the pipe system.

—▶ Flushing via bypass:
Close the shut-off devices before and after the flowmeter.

- or -

—▶ Flushing via flowmeter:
Install the operating filter before the flowmeter. In this case select the mesh width of the operating filter in accordance with the pumped liquid.

9.2.2 Checking the function

1. —▶ Check the flow direction of the flowmeter.
2. —▶ Check the installation of the pick up and optional temperature sensor.
3. —▶ Check for leaks at the pipe thread/connecting flange.
4. —▶ Check the electrical installation.
5. —▶ Check the power supply.

9.2.3 Commissioning the flowmeter

ATTENTION

Increased wear and/or blockade through solid particles or abrasive fine particles in the liquid.

- ▶ Protect the flowmeter through correspondingly dimensioned operating filters in the pipe system.

ATTENTION

Measuring error when the pressure drops below the minimum pressure outlet at the outlet.

- ▶ Ensure that sufficient counter-pressure exists at the outlet by routing the piping upwards.

ATTENTION

Measuring error through gas inclusion in the pipe system.

- ▶ Before commissioning, make sure that the flowmeter is filled.
- ▶ Vent the pipe system.

Requirement:

- ✓ The ambient conditions correspond to the operating data
- ✓ Flowmeter installed correctly in the pipe system ↪ Installation, removal, Page 13
- ✓ Flowmeter connection to the pipe system is stress-free
- ✓ Pipe system is free of impurities
- ✓ Pipe system vented
- ✓ Shut-off devices in the feed line and outlet opened

➔ Switch on the measuring system.

⇒ The flowmeter measures when the pick up generates a signal.

9.3 Decommissioning

9.3.1 Switching off the flowmeter

ATTENTION

Damage to the measuring unit.

In the case of strong changes to the flow rate (for example, rapid shutdown, pulsations, etc.) there is a danger of excessive pressure differences.

- ▶ Ensure that the pressure loss of the flowmeter does not exceed the values specified on the rating plate or the substitute operating data.

➔ Ensure that the pressure loss of the flowmeter does not exceed the values specified on the rating plate or the standardized substitute operating data ↪ Technical data, Page 9.

⇒ When the flow through the flowmeter is stopped, the generation of the signal stops automatically. No further measures are required to switch off.

9.4 Recommissioning

9.4.1 Recommissioning the flowmeter

ATTENTION

Damage to device through hard, gummy or crystallized pumped liquid in the flowmeter.

- ▶ Before recommissioning, ensure that there is no hard, gummy or crystallized pumped liquid in the flowmeter.

Requirement:

- ✓ The ambient conditions correspond to the operating data
- ✓ Flowmeter connection to the pipe system is stress-free
- ✓ Pipe system is free of solid particles
- ✓ Pipe system vented
- ✓ Shut-off devices in the feed line and outlet opened

➔ Switch on the system.

⇒ The flowmeter is ready to operate.

10 Maintenance

10.1 Required maintenance

Flowmeters are fundamentally maintenance-free. Under observance of the operating limits ↴ Technical data, Page 9, no significant change in the characteristics could be established, even after years of use in many cases. Stresses lying clearly above the rated flow rate can, however, result in excessive wear. In the case of liquids with higher abrasiveness (for example plastic components with fillers, etc.) strongly accelerated wear can occur in the flowmeter.

Notice In cases of doubt the manufacturer recommends already carrying out the first inspection after twelve weeks operation time.

10.2 Recalibration of the flowmeter

In order to maintain the high measuring precision of the flowmeter, the manufacturer recommends carrying out the first recalibration after about one year of operation. The results reveal any wear starting on the measuring unit. The interval at which recalibrations are actually required depends strongly on the operating conditions of the flowmeter.

Calibration of the flowmeter is offered as an option.

11 Disposal

11.1 Dangers during disposal



The following safety instructions must be observed strictly:

- Collect any discharging pumped liquid safely and dispose of it in an environmentally compatible manner in accordance with the applicable local regulations.
- Ensure that the collection tank for emitted liquids is sufficiently large.
- Neutralize residues.

11.2 Dismantling and disposing of the flowmeter

Personnel qualification:	<input type="checkbox"/> Fitter
Personal protective equipment:	<input type="checkbox"/> Work clothing <input type="checkbox"/> Face protection <input type="checkbox"/> Protective gloves <input type="checkbox"/> Safety boots
Aids:	<input type="checkbox"/> Solvents or industrial cleaners suitable for the pumped liquid <input type="checkbox"/> Collection tank



⚠ DANGER

Risk of death resulting from electric shock when removing the optional electrical heating system.

- ▶ Ensure that the electrical power supply is de-energized and is secured against being switched back on.
- ▶ The flowmeter may only be disconnected from the power supply by an authorized electrician.



⚠ WARNING

Danger of poisoning and environmental damage through residues.

- ▶ Wear personal protective clothing during all the work. Ensure face protection.
- ▶ Before disposal collect any pumped liquid still present safely and dispose of it in an environmentally compatible manner in accordance with the applicable local regulations.
- ▶ Before disposing neutralize the residues.

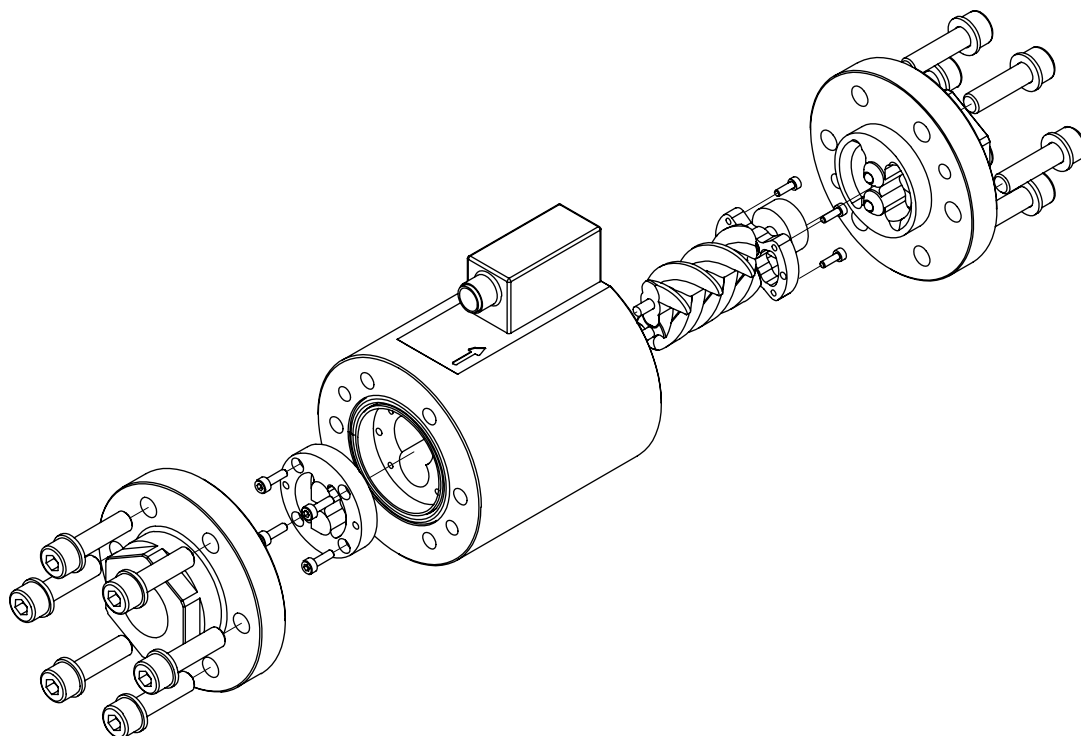

Fig. 9: Exploded view

Requirement:

- ✓ Flowmeter cooled down to the ambient temperature and disconnected from the pipe system
 - ✓ Flowmeter drained completely
 - ✓ Flowmeter placed at a location suitable for dismantling
1. ➤ Dismantle the flowmeter and disassemble it into its individual parts.
 2. ➤ Clean residues of the pumped liquid from the individual parts.
 3. ➤ Separate sealing elements made of elastomer from the flowmeter and dispose of them separately.
 4. ➤ Recycle iron parts.

12 Troubleshooting

12.1 Possible faults

12 Troubleshooting

12.1 Possible faults

Faults can have different causes. The following tables list the symptoms of a fault, the possible causes and measures for troubleshooting.

In the case of faults please contact the manufacturer. Under services@kral.at.

Identification	Fault
1	Flowmeter leaks
2	No flow rate
3	Flowmeter does not generate a pulse
4	Pressure loss too high
5	Measured values not realistic

12.2 Troubleshooting

Fault identification	Cause	Remedy
1	Seal damaged	<ul style="list-style-type: none"> Check the chemical resistance of the seal.
2	Foreign particles in the liquid and/or flowmeter	<ul style="list-style-type: none"> Use the commissioning filter.
3	Pick up not connected correctly	<ul style="list-style-type: none"> Check the power supply for the pick up.
3	Pick up defective	<ul style="list-style-type: none"> Check the function of the pick up. In the process observe the operating instructions of the pick up.
3	Pick up defective	<ul style="list-style-type: none"> Check the function of the pick up.
2	Inlet pressure too low	<ul style="list-style-type: none"> Increase the inlet pressure.
4	Viscosity of the liquid too high	<ul style="list-style-type: none"> Increase the temperature. When doing so observe the temperature range.
3	Flow rate too low	<ul style="list-style-type: none"> Increase the flow rate.
4	Flow rate too high	<ul style="list-style-type: none"> Reduce the flow rate.
5	Airlocks	<ul style="list-style-type: none"> Deaerate the system and check for leaks.
5	Outgassing	<ul style="list-style-type: none"> Increase the system pressure. Reduce the temperature.
5	Pulsations too high	<ul style="list-style-type: none"> Use another feed pump. Carry out changes to the system.
5	Back pressure too low	<ul style="list-style-type: none"> Increase the back pressure.
5	Flow rate fluctuations too high	<ul style="list-style-type: none"> Ensure a continuous flow rate by taking suitable measures (use of a different pump, valve, damper, etc.).
5	Strongly deviating operating data	

Fault identification					Cause	Remedy
						Adapt the operating data to the flowmeter.
–	2	3	4	5	Wear at the measuring unit and bearings	Filter out the abrasive materials.
–	2	3	–	–	Flow impaired at the system end	Check whether the fluid flows in the system (pump in operation, slide valve opened, etc.). Check whether shut-off devices before and after the flowmeter are opened.
–	2	3	–	–	Flowmeter switched to bypass	Switch the flowmeter to through-flow.

Tab. 7: Fault table

13 Appendix

13.1 Tightening torque for screws with metric screw threads and head contact surfaces

Thread	Tightening torque [Nm]				+ Wedge lock washers	Rust-proof A4-70	Stainless steel screws A2 and A4	
	5.6	5.8	10.9	8.8+ Alu*	8.8	Property class 70	Property class 80	
M 3	0.6	1.5	–	1.2	1.5	1.1	–	–
M 4	1.4	2.9	4.1	2.3	3.0	2.0	–	–
M 5	2.7	6.0	8.0	4.8	6.0	3.9	3.5	4.7
M 6	4.7	9.5	14.0	7.6	10.3	6.9	6.0	8.0
M 8	11.3	23.1	34.0	18.4	25.0	17.0	16.0	22.0
M 10	23.0	46.0	68.0	36.8	47.0	33.0	32.0	43.0
M 12	39.0	80.0	117	64.0	84.0	56.0	56.0	75.0
M 14	62.0	127	186	101	133	89.0	–	–
M 16	96.0	194	285	155	204	136	135	180
M 18	133	280	390	224	284	191	–	–
M 20	187	392	558	313	399	267	280	370
M 24	322	675	960	540	687	460	455	605

Tab. 8: Tightening torques metric screw thread

* Reduced tightening torque when screwing into aluminium

13.2 Tightening torques for screw plugs with thread measured in inches and elastomer seal

Tightening torque [Nm]	
Thread	Galvanized + stainless steel
G 1/8"	13.0
G 1/4"	30.0
G 3/8"	60.0
G 1/2"	80.0
G 3/4"	120
G 1"	200
G 1 1/4"	400
G 1 1/2"	450

Tab. 9: Tightening torques, thread measured in inches

13.3 Contents of the Declaration of Conformity

The products described in these instructions are machinery in the sense of the Directive 2006/42/EC. The original of the EC Declaration of Conformity is enclosed with the machinery at delivery.

The machinery fulfils all the relevant provisions of the following directives:

Number	Name	Remark
2006/42/EC	Machinery Directive	–
2014/68/EU	Pressure Equipment Directive	–
2014/30/EU	Directive on Electromagnetic Compatibility	Only for machinery with electrical components
2014/35/EU	Low Voltage Directive	Only for machinery with electrical components

Tab. 10: Directives observed

Directory of figures

Fig. 1	Type code.....	8
Fig. 2	Rating plate	8
Fig. 3	Pressure pulses.....	9
Fig. 4	Pin assignment / Connection diagram.....	10
Fig. 5	Dimensional drawing pipe thread	10
Fig. 6	Structure of the flowmeter	11
Fig. 7	Installation types.....	14
Fig. 8	Flowmeter with trace heating	16
Fig. 9	Exploded view	23

Directory of tables

Tab. 1	Target groups	3
Tab. 2	Type code.....	8
Tab. 3	Maximum values.....	9
Tab. 4	Pick up.....	9
Tab. 5	Dimensions and weights - pipe thread connection	10
Tab. 6	Installation types.....	14
Tab. 7	Fault table.....	24
Tab. 8	Tightening torques metric screw thread	26
Tab. 9	Tightening torques, thread measured in inches	26
Tab. 10	Directives observed	26



KRAL

